

# CHAPTER 2 - Quality Assurance, Construction and Miscellaneous Design Issues

## 2.1 INTRODUCTION

This chapter discusses some miscellaneous requirements involved with the design and construction of concrete masonry. While they do not directly address the ability of concrete masonry to resist external loads, these items must be considered in order to obtain good performance from concrete masonry.

The chapter begins with a presentation of the various quality assurance requirements and continues with descriptions of some of the tests that need to be performed to ensure that constructed concrete masonry satisfies the quality assurance plan. Different types of control joints and methods for controlling cracking in concrete masonry walls are also discussed. The chapter concludes with a brief discussion on fire resistance, sound insulation and energy performance of concrete masonry buildings.

## 2.2 QUALITY ASSURANCE

TMS 402 defines quality assurance as the administrative and procedural requirements established by the contract documents to assure that masonry is constructed in accordance with the contract documents. The actions required to achieve quality assurance include *testing* to ensure that the materials are in accordance with the construction documents and *inspections* to ensure that workmanship is also acceptable. Quality assurance processes are typically performed by the owner or owner's representative. The owner hires the structural engineer (or architect) of record to develop a *quality assurance plan* in accordance with the applicable codes and standards. The design professional must include the quality assurance plan as part of the contract documents. The owner also hires a *testing agency* and an *inspection agency* (testing and inspections are often performed by the same agency) to perform the testing and inspections required by the quality assurance plan. The testing agency samples and tests the masonry materials as required and reports the results to the owner, engineer, inspection agency and contractor. The inspection agency inspects and evaluates the construction at intervals specified by the quality assurance plan and provides inspection reports to the engineer and contractor. Neither the testing agency or inspection agency is authorized to approve or reject any portion of the work. However, they are required to bring any deficiencies or non-conforming items to the attention of the owner, engineer and contractor.

In addition to the standard inspection requirements outlined in the codes there are also *special inspections*, which must be performed on certain critical building components by persons with specialized training and expertise called *special inspectors*. Special inspections may be *continuous special inspections*, which consist of full time observation by the

special inspector at all times while the work is being performed, or *periodic special inspections*, which consist of intermittent observations at selected stages of construction and at the completion of the work.

The IBC also requires that for some buildings, *structural observations* be performed by a licensed professional to verify that the construction is in general conformance with the approved construction documents. Structural observation is typically performed by the architect or engineer of record or his representative and is carried out in addition to other inspections by the inspection agency, special inspectors, and building officials. The structural observer is typically the only participant in the quality control program that understands the intent of the design. Therefore, the presence of a knowledgeable observer during key stages of construction of the gravity and lateral load resisting systems improves the likelihood of conformance with the contract documents and reduces the possibility of gross errors and omissions. It should be noted that the role of the structural observer involves, as the IBC states, "a visual observation of the structural system by a registered design professional for general conformance to the approved construction documents." The structural observer is not responsible for certifying or ensuring conformance to all of the specific requirements of the construction documents, nor does structural observation waive the inspection or testing requirements that are required as part of the quality control program.

The structural observations required by the IBC consist of structural observations for seismic resistance and structural observation for wind requirements. Structural observations for seismic resistance are required for structures assigned to Seismic Design Category D, E or F when one or more of the following conditions exist:

1. The structure is classified as Risk Category III or IV.
2. The height of the structure is over 75 feet.
3. The structure is assigned to Seismic Design Category E and is classified as risk Category I or II and is over two stories tall.
4. Structural observations are required by the registered design professional responsible for the structural design.
5. Structural observations are required by the building official.

Several jurisdictions expand the scope of structural observations for seismic resistance beyond the above conditions.

Structural observations for wind requirements are required when the nominal design wind speed exceeds 110 mph and one or more of the following conditions exist:

1. The structure is classified as Risk Category III or IV.
2. The height of the structure is over 75 feet.
3. Structural observations are required by the registered design professional responsible for the structural design.
4. Structural observations are required by the building official.

As with structural observations for seismic resistance, several jurisdictions require structural observations for wind resistance for a wider range of conditions than those described above.

TMS 402<sup>2.1</sup> provides three levels of quality assurance, which are designated as quality assurance levels A, B and C in order of increasingly rigorous quality assurance requirements. In general, Level A quality assurance requires only acceptable certificates for the materials and minimum inspection to verify compliance with the construction documents; Level B quality assurance involves testing at the start of the project and

inspections at critical stages during construction; and Level C quality assurance requires testing throughout the project and inspections at the beginning of and continuously during the construction of the masonry. Tables 2.2.1 to 2.2.3 provide details on the requirements of the three levels of quality assurance.

The quality assurance program used for a project depends on the method used for design and the type of building being constructed. Masonry buildings designed with methods that take the most advantage of masonry properties require higher level of quality assurance as do buildings that are designated as essential facilities. Table 2.2.4 summarizes the TMS 402 quality assurance requirements for various buildings. As can be seen from the table, essential buildings designed using allowable stress or strength designed procedures require the highest level of quality assurance (Level C), while most non-essential buildings require Level B procedures. TMS 402 permits buildings designed with empirical design procedures to be constructed using Level A quality control procedures. However, it should be noted that empirical design of masonry is not permitted in most parts of the western United States.

**TABLE 2.2.1 Level A Quality Assurance**

Minimum Tests and Submittals	Minimum Inspection
None	Verify Compliance with the approved submittals

TABLE 2.2.2 Level B Quality Assurance

Minimum Tests and Submittals	Minimum Inspection		
	Inspection Task	Frequency	
		Continuous	Periodic
Verification of slump flow and Visual Stability Index (VSI) as delivered to the project site for self-consolidating grout	1. Verify compliance with the approved submittals		X
	2. As masonry construction begins, verify the following are in compliance:		
	a. Proportions of site-prepared mortar		X
	b. Construction of mortar joints		X
	c. Grade and size of prestressing tendons and anchorage		X
	d. Location of reinforcement, connectors, and pre-stressing tendons and anchorages		X
Verification of $f_m$ prior to construction except for masonry that is exempted	e. Pre-stressing technique		X
	3. Prior to grouting, verify the following are in compliance:		
	a. Grout space		X
	b. Grade type and size of reinforcement and anchor bolts, and pre-stressing tendons, and anchorages		X
	c. Placement of reinforcement, connectors, and pre-stressing tendons and anchorages		X
	d. Proportions of site-prepared grout and pre-stressing grout for bonded tendons		X
	e. Construction of mortar joints		X
	4. Verify during construction:		
	a. Size and location of structural elements		X
	b. Type size and location of anchors, including other details of anchorage of masonry to structural members, frames, or other construction		X
	c. Welding of reinforcement	X	
	d. Preparation, construction, and protection of masonry during cold weather (temperature below 40°F (4.4°C)) or hot weather (temperature above 90°F (32.2°C))		X
	e. Application and measurement of prestressing force	X	
	f. Placement of grout and prestressing grout for bonded tendons is in compliance	X	
	5. Observe preparation of grout specimens, mortar specimens, and/or prisms		X

**TABLE 2.2.3 Level C Quality Assurance**

Minimum Tests and Submittals	Minimum Inspection		
	Inspection Task	Frequency	
		Continuous	Periodic
Verification of $f_m$ prior to construction and for every 5,000 sq. ft. during construction	1. Verify compliance with the approved submittals		X
	2. Verify the following are in compliance:		
Verification of proportions of materials in pre-mixed or pre-blended mortar prestressing grout and grout other than self-consolidating grout as delivered to the site	a. Proportions of site-prepared mortar		X
	b. Grade type and size of reinforcement and anchor bolts, and pre-stressing tendons, and anchorages		X
	c. Placement of masonry units and construction of mortar joints		X
	d. Placement of reinforcement, connectors, and prestressing tendons and anchorages	X	
	e. Grout space prior to grouting	X	
	f. Placement of grout and prestressing grout for bonded tendons	X	
	g. Size and location of structural elements		X
	h. Type size and location of anchors, including other details of anchorage of masonry to structural members, frames, or other construction	X	
	i. Welding of reinforcement	X	
	j. Preparation, construction, and protection of masonry during cold weather (temperature below 40°F (4.4°C)) or hot weather (temperature above 90°F (32.2°C))		X
Verification of slump flow and VSI as delivered to the site for self-consolidating grout	k. Application and measurement of prestressing force	X	
	3. Observe preparation of grout specimens, mortar specimens, and/or prisms	X	

**TABLE 2.2.4 Quality Assurance Requirements**

	Empirical Design, Veneer, Glass Unit Masonry (When Permitted)	Strength or Allowable Stress Design, Prestressed Masonry
Risk Category I, II & III	Level A	Level B
Risk Category IV	Level B	Level C

### 2.2.1 Verification of Masonry Compressive Strength

A major aspect of quality assurance in concrete masonry construction is the verification of the specified masonry compressive strength,  $f'_m$ . TMS 602, *Specification for Masonry Structures*<sup>2.2</sup> stipulates that the compressive strength of masonry may be determined by either the unit strength method or the prism test method.

#### Unit Strength Method

When using the unit strength method, the compressive strength of the masonry is based on the properties of the constituent materials (concrete masonry units, mortar and grout). Table 1.6.1 provides the values of  $f'_m$  for the various net area compressive strengths of units and types of mortar used in construction. In addition the construction should adhere to the following requirements:

1. Grout compressive strength must equal or exceed  $f'_m$  but must not be less than 2000 psi.
2. Thickness of bed joints must not exceed 5/8-inch.

For units less than 4 inches in height, 85% percent of the values provided should be used. Methods for sampling and testing to determine the strength of concrete masonry units and grout are described in the next section.

#### Prism Test Method

The prism test involves testing concrete masonry assemblages to determine the masonry compressive strength. The details of prism testing are described in Section 2.3.4.

2.3 TESTING OF CONCRETE MASONRY

The tests required during construction of concrete masonry depend on the quality assurance plan being used. Tests are often performed on either the individual components that make up concrete masonry (units, mortar and grout) or on the concrete masonry assemblage.

2.3.1 Tests on Concrete Masonry Units

Typical tests performed on concrete masonry units include tests to determine compressive strength, moisture content, absorption, and shrinkage as well as a verification of the dimensions of the units. ASTM standard C140, "Standard Methods for Sampling and Testing Concrete Masonry Units and Related Units" 2.3 provides criteria by which units are to be selected for testing and specifies procedures that should be followed when performing the various tests. Table 2.3.1 lists the number of specimens that must be typically tested, depending on the number of units manufactured in each lot. A **lot** refers to any number of units that are manufactured using the same materials, concrete mix design, manufacturing process and curing method. The selected specimens must be representative of the lot from which they were selected. It is not necessary to test every size and configuration of units used on a project.

After sampling, each specimen must be marked so that it can be identified. Markings must not cover more than 5% of the area of a unit. The units should be weighed immediately after sampling and the weight recorded as the **received weight**,  $W_r$ .

TABLE 2.3.1  
Number of Concrete Masonry Units to be Tested

Number of Units in Lot	Number of Units to be Tested
Less than 10,000	6
10,000 to 100,000	12
Greater than 100,000	6 for every 50,000 units contained in the lot

Measurement of Dimensions

Three full size specimens must be measured for width, height, and minimum thickness of face shells and webs. The overall dimensions of concrete masonry units must be verified using a steel scale having divisions of no greater than 1/10<sup>th</sup> of an inch. The width,  $W$ , is recorded across the top and bottom bearing surfaces at the mid-length of the unit. The height,  $H$ , is measured at the mid-length of each face and the length,  $L$ , at mid-height of each face.

Face shell thickness,  $t_{fs}$ , and web thicknesses,  $t_w$ , must be measured with a caliper rule having divisions no greater than 1/100<sup>th</sup> of an inch at the thinnest point 1/2-inch from the bottom

of the unit. Grooves, scores and similar details are to be ignored in the measurements.

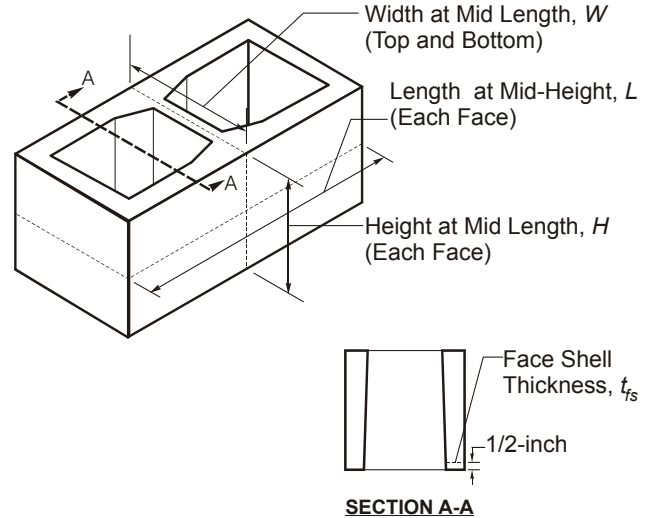

FIGURE 2.3.1 Location of Measurements for Concrete Masonry Units

Absorption

Absorption tests may be performed on full-size units or on specimens saw-cut from full-size units. The test specimens are immersed in water at a temperature of 60 to 80°F for 24 hours and weighed while suspended by a metal wire and completely submerged to obtain the **immersed weight**,  $W_i$ . After this, the specimens are removed from the water, allowed to drain for 1 minute and weighed again to determine the **saturated weight**,  $W_s$ . The oven-dry weight,  $W_d$ , is then obtained by drying the specimen in a ventilated oven at a temperature of 212 to 239°F for at least 24 hours and until two successive weighings at intervals of 2 hours show a reduction in weight no more than 0.2%. The difference between the saturated weight and the immersed weight is equal to the weight of the amount of water displaced by the specimen. Therefore the net volume,  $V_n$ , of the specimen can be determined from:

$$V_n (\text{ft}^3) = \frac{W_s - W_i}{62.4} \tag{2.3.1}$$

and the absorption of the unit is calculated as follows:

$$\text{Absorption (lb/ft}^3) = \frac{W_s - W_d}{W_s - W_i} \times 62.4 \tag{2.3.2}$$

or as a percentage of the oven-dry weight:

$$\text{Absorption (\%)} = \frac{W_s - W_d}{W_d} \times 100 \tag{2.3.3}$$

where all weights are in pounds. Note that the absorption for concrete masonry units should not exceed the limits shown in Table 1.4.2.

#### Moisture Content

The moisture content of the specimen at the time it was sampled is given by:

$$\text{Moisture Content (\%)} = \frac{W_r - W_d}{W_s - W_d} \times 100 \quad (2.3.4)$$

where  $W_r$  is the **received weight** that is obtained by weighing the unit immediately after sampling and marking.

#### Density

The oven dry density,  $D$ , of the specimen is equal to:

$$D \text{ (lb/ft}^3\text{)} = \frac{W_d}{W_s - W_i} \times 62.4 \quad (2.3.5)$$

#### Average Net Area

The average net area,  $A_n$ , is given by:

$$A_n \text{ (in}^2\text{)} = \frac{V_n \times 1728}{H} \quad (2.3.6)$$

#### Equivalent Thickness

The equivalent thickness,  $T_e$ , of concrete masonry is equal to:

$$T_e \text{ (in)} = \frac{V_n \times 1728}{L \times H} \quad (2.3.7)$$

#### Compressive Strength

The compressive strength of concrete masonry units must be measured with a testing machine that has an accuracy of  $\pm 1.0\%$  over the anticipated load range. The loading surfaces must cover the entire surface of the concrete masonry unit and be stiff enough to distribute the applied load evenly over the specimen.

Before testing in compression, specimens must be stored in the laboratory for at least 48 hours at a temperature of  $75 \pm 15^\circ\text{F}$  and a relative humidity of less than 80%. Unsupported projections that are longer than the thickness of the projection must be removed by saw-cutting.

After testing, the **net area compressive strength** of the concrete masonry unit is given by:

$$\text{Net Area Compressive Strength, (psi)} = \frac{P_{\max}}{A_n} \quad (2.3.8)$$

where  $P_{\max}$  is the maximum compressive load in pounds. The net area compressive strength should be reported to the nearest 10 psi.

#### Linear Drying Shrinkage

Linear drying shrinkage is the change in linear dimension of a concrete masonry unit when its moisture content changes from a saturated condition to an equilibrium weight and length under specified accelerated drying conditions. It is an important property because the dimensional changes of units at various moisture contents have a significant effect on the cracking that may occur in completed concrete masonry wall. ASTM C426, "Standard Test Method for Linear Shrinkage of Concrete Masonry Units"<sup>2,4</sup> provides procedures for evaluating the linear drying shrinkage. Units are immersed in water at a temperature of  $73.4 \pm 2^\circ\text{F}$  for about 48 hours. The units are then dried, in air and in an oven, following a specific procedure outlined in ASTM C426 until the average length change in of the specimen is 0.002% or less over a span of 6 days, and the average weight loss in 48 hours is less than 0.2% of the previously determined weight. The linear drying shrinkage,  $S$ , is given by:

$$S = \frac{\Delta L}{G} \quad (2.3.9)$$

Where  $\Delta L$  is the change in length from a saturated state to an equilibrium state, and  $G$  is the test specimen gage length. As stated in Section 1.4.1, the linear drying shrinkage of units when they are delivered to the purchaser should not be greater than 0.065%.

### 2.3.2 Tests on Grout

#### Compressive Strength

The requirements for field and laboratory sampling and testing of grout are contained in ASTM Standard C1019, "Standard Test Method for Sampling and Testing Grout"<sup>2,5</sup>. The standard covers procedures for field and laboratory sampling and testing of grout for masonry construction. Grout testing procedures are designed to simulate conditions that exist in the structure after it is built. Since concrete masonry units absorb water from the grout when it is placed in cavities during construction, the excess water in test specimens must be removed to provide compressive strengths that are indicative of the strength in a constructed wall. This is achieved by pouring the grout specimen between concrete masonry units of the same type and moisture characteristics, as shown in Figure 2.3.2.

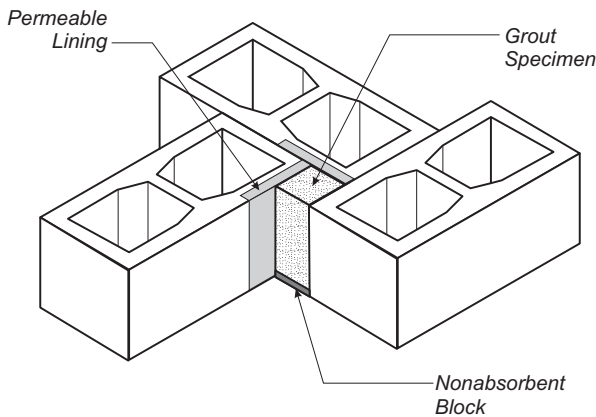

FIGURE 2.3.2 Grout Mold for Testing (Note: Front Unit Not Shown to Allow View of Specimen)

The grout specimen must have a square cross-section with each side equal to 3 inches or greater, and must be twice as high as it is wide. A thin permeable lining, such as a paper towel, should be placed between the specimen and the units to prevent the grout from bonding to the concrete masonry units. This enables the specimen to be removed from the mold for testing while still allowing excess water to be absorbed. In addition, a nonabsorbent block should be placed at the base of the specimen to prevent loss of water from the base of the mold.

Specimens are removed from molds between 24 to 48 hours after being poured and stored in a moist room or water storage tank until testing. The average cross-sectional area is obtained by measuring the width of each face of the specimen at mid-height, calculating the average width of opposite faces, and multiplying the averages. The compressive strength is obtained by dividing the maximum load resisted by the specimen by the average cross-sectional area. Compressive strength of grout is typically recorded to the nearest 10 psi.

### Slump

The slump of grout is obtained primarily to evaluate its workability. While some correlation has been found between slump measured in controlled laboratory environments and the compressive strength of grout or concrete, there is no similar relationship under typical field conditions. Procedures for obtaining slump of grout are contained in ASTM Standard C143, "Standard Test Method for Slump of Hydraulic-Cement Concrete."<sup>2.6</sup> The procedures can be used for concrete with coarse aggregate up to a maximum size of 1-1/2 inches and are thus applicable to grout, which is essentially concrete with smaller-sized aggregate. The grout is placed in a standard mold, which is then raised in an upward vertical motion. The slump is measured as the distance between the top of the mold and the displaced original center of the top surface of the specimen, as shown in Figure 2.3.3. The typical slump for workable grout is in the range of 8-11 inches. Self-consolidating grout is usually very fluid and thus the typical

slump measurement is unsuitable. Instead, the lateral spread of the grout is measured.

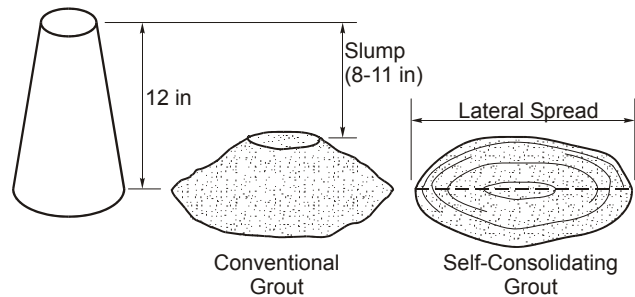

FIGURE 2.3.3 Measurement of Grout Slump

### 2.3.3 Tests on Mortar

As stated in Section 1.4.2, mortar may be specified either by the volumetric proportions of the constituent materials or by its properties obtained from testing (not by both). ASTM C270 "Standard Specification for Mortar for Unit Masonry."<sup>2.7</sup> can be used to specify mortar using either method. When mortar is specified by volumetric proportions, no sampling or testing of the mortar is required. Only field verification of the correct proportions of mortar mixes is necessary. When mortar is specified by property requirements, the mortar must satisfy the property specification requirements in Table 1.4.3. Testing in accordance with ASTM C270 is only applicable to mortar prepared in a laboratory and should not be used to evaluate site-prepared mortars. This is because the water content of mortar mixed at a construction site is significantly different from the mortar in a masonry wall. Once mortar is placed, water is absorbed by the masonry units and the mortar properties begin to change. The properties of site prepared mortar also depend on conditions such as the temperature, humidity and wind speed that exist during construction.

Tests on site-prepared mortar should be performed in accordance with ASTM C780 "Test Method for Preconstruction and Construction Evaluation of Mortars for Plain and Reinforced Unit Masonry."<sup>2.8</sup> The standard provides methods for determining the consistency, consistency retention, aggregate ratio, water content; air content, compressive strength, and splitting tensile strength of site-prepared mortar. Compression tests on site-prepared mortars are performed only to verify mortar consistency during construction and are not required to satisfy the property specification requirements of ASTM C270.

### Compressive Strength

ASTM C270 states that compressive strength tests in a laboratory should be performed in accordance with ASTM C109 "Standard Test Method for Compressive Strength of Hydraulic Cement Mortars."<sup>2.9</sup> The standard, which does not



apply to site-prepared mortar, contains detailed procedures for testing mortar to determine if it satisfies the property specification requirements. Tests are performed on 2-inch cubes, or on 2-inch diameter, 4-inch high cylinder specimens. Mortar is mixed and placed in molds and compacted by tamping in two equal layers. After curing in a moist room for about 24 hours, the molds are stripped and the cubes placed in saturated lime water until they are tested. The compressive strength,  $fm$ , of the mortar is given by

$$fm = \frac{P}{A} \quad (2.3.10)$$

where  $P$  is the maximum compressive load and  $A$  is the area of the loaded surface. The compressive strength is reported to the nearest 10 psi.

#### Air Content

The air content of masonry is determined as stipulated in ASTM C270. First, the density of air free mortar,  $D$ , is determined with the following equation:

$$D = \frac{W_1 + W_2 + W_3 + W_4 + V_w}{\frac{W_1}{P_1} + \frac{W_2}{P_2} + \frac{W_3}{P_3} + \frac{W_4}{P_4} + V_w} \quad (2.3.11)$$

where

- $W_1$  = weight of portland cement, g
- $W_2$  = weight of hydrated lime, g
- $W_3$  = weight of mortar cement or cement, g
- $W_4$  = weight of oven-dry sand, g
- $P_1$  = density of portland cement, g/cm<sup>3</sup>
- $P_2$  = density of hydrated lime, g/cm<sup>3</sup>
- $P_3$  = density of mortar cement or cement, g/cm<sup>3</sup>
- $P_4$  = density of oven-dry sand, g/cm<sup>3</sup>

The air content,  $A$ , in percent is then determined as follows:

$$A = 100 - \frac{W_m}{4D} \quad (2.3.12)$$

where  $W_m$  is the weight of 400 mL of mortar.

#### 2.3.4 Tests on Concrete Masonry Assemblages

The previous sections describe tests to determine if the units, mortar and grout – the components of the concrete masonry assemblage – satisfy the quality assurance provisions. Alternatively, testing can be performed on the concrete masonry assemblage to ascertain that when placed, the composite masonry assemblage satisfies the quality assurance provisions. Prism tests to determine the masonry compressive strength,  $f'_m$ , are the most common tests performed on the concrete masonry assemblage.

The prisms are constructed in stack bond as shown in Figure 2.3.4, with materials representative of those used during construction. When partially grouted construction is used, two sets of prisms should be constructed; one set solid grouted and the other ungrouted. As shown in Figure 2.3.4(b), masonry prisms may be constructed with units that are saw-cut from whole units. When cutting the units, the entire cross web should be included in the prism. The use of reduced length units is encouraged because they are less likely to be damaged and are more likely to be properly capped and have uniform contact during testing.

After the prism is constructed and stored until the selected test age, as stipulated in ASTM C1314<sup>2,10</sup>, it is loaded in compression until failure and the maximum load recorded. The maximum compression load is divided by the net cross sectional area of the prism to obtain the masonry prism strength. The compressive strength of the masonry is then determined by averaging the values obtained for each set of three prisms.

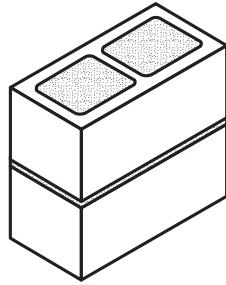

Grouted Prism

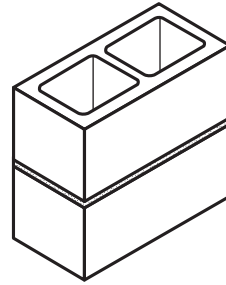

Ungouted Prism

(a) Prisms Using Whole Units

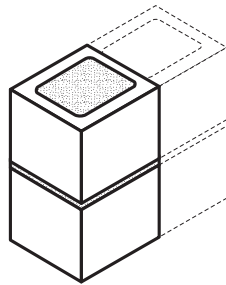

Grouted Prism

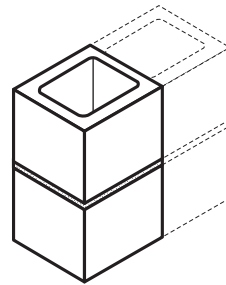

Ungouted Prism

(b) Prisms Using Cut Units

FIGURE 2.3.4 Masonry Prism Construction

## 2.4 MOVEMENT JOINTS AND CONTROL OF CRACKING IN CONCRETE MASONRY

### 2.4.1 Volumetric Changes in Concrete Masonry

Dimensional changes in masonry occur because of three phenomena - contraction due to temperature changes, carbonation shrinkage, and drying shrinkage. The National Concrete Masonry Association (NCMA) has a Technical Note on control joints in concrete masonry walls (TEK 10-1A)<sup>2,11</sup> that provides a methodology for calculating shrinkage due to each of these effects. As with most materials, concrete masonry increases in volume as temperatures increase. The coefficient of thermal expansion for concrete masonry ranges from 0.000025 to 0.000055 in/in/°F. Thus for a temperature variation of 70°F, and using a typical value of 0.000045 in/in for the thermal coefficient, a 50 foot long concrete masonry wall would shrink about 0.2 inches due to temperature variations alone. Volumetric changes due to temperature variations are theoretically reversible.

Carbonation shrinkage occurs due to the reaction between the cementitious materials in the masonry and the carbon dioxide in the atmosphere. Carbonation shrinkage occurs over an extended period and is irreversible. Masonry with high cement content, as is often required in units and grout to achieve higher compressive strengths, will experience more carbonation shrinkage over time. A coefficient of 0.00025in/in can be generally used for calculating the amount of shrinkage due to carbonation. This means that a 50 ft long wall will shrink about 0.15 inches due to carbonation shrinkage alone.

Drying shrinkage takes place during the early curing and drying of the masonry. As the grout hydrates and the masonry units dry out, the loss of moisture leads to a reduction in volume. The amount of drying shrinkage that occurs depends on, among other factors, the properties of the materials used and the weather conditions at the jobsite. ASTM Specification C 90<sup>2,12</sup> provides requirements for the water absorption and linear drying shrinkage of load-bearing concrete masonry units. In general, units with normal weight aggregates tend to shrink less than units manufactured using lightweight aggregates. In addition, high strength units, with the corresponding high cement content, will shrink more. The properties of the grout also affect the amount of drying shrinkage that occurs in concrete masonry. As with concrete masonry units, high-strength grout tends to shrink more. This leads to a larger overall shrinkage in a concrete masonry wall if, as expected, there is good bond between the grout and the units. Additives such as grout-aid are often used to improve grout shrinkage characteristics and bond to concrete masonry units.

The weather conditions at the job site also contribute to the dimensional changes in concrete masonry. Clearly, there will be more shrinkage in hot, arid climates as the amount of moisture lost to the atmosphere is greater than in cooler, humid climates.

### 2.4.2 Crack Control in Concrete Masonry

Cracks in concrete masonry construction occur when the volumetric changes that occur due to drying or temperature changes are restrained by relatively rigid elements such as foundations, cross walls or adjacent framing. Theoretically, stresses are induced not only by shrinkage when the masonry reduces in volume, but also when it expands as temperatures increase. However, cracks due to shrinkage are much more common and so the term “shrinkage cracks” is generally used for all cracks due to dimensional changes in the masonry. When masonry shrinkage is restrained, tensile stresses are induced as shown in Figure 2.4.1. If the tensile stresses exceed the cracking stress of the masonry, cracking occurs.

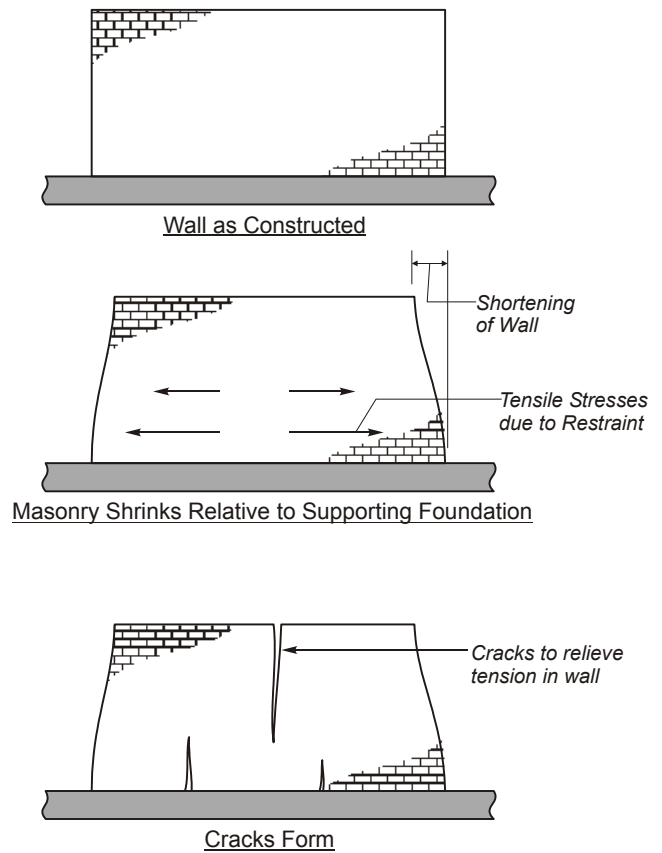

**FIGURE 2.4.1 Exaggerated Illustration of Cracks in Masonry Due to Restraint of Dimensional Changes**<sup>2,13</sup>

In addition to cracks caused by an overall change in volume, there is a component of shrinkage cracking that occurs due to the difference in moisture content between the grout and the concrete masonry units. The units absorb water from the grout that is placed in the cells. As this moisture evaporates

from the exterior surface of the wall, the face shells of the units attempt to shrink and are restrained by the interior of the wall, which still contains a significant amount of water. This results in tensile stresses on the exterior of the masonry as shown in Figure 2.4.2. Cracking occurs if the induced stresses exceed the cracking stress of the concrete masonry units. It is thus important to ensure that the masonry units are not wet when they are placed since the loss of additional moisture will cause more drying shrinkage and additional cracking.

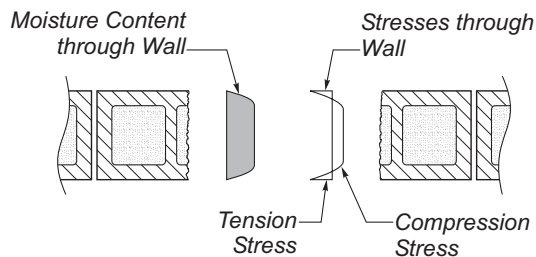

**FIGURE 2.4.2** Moisture Content and Shrinkage Stresses in a Concrete Masonry Wall<sup>2,14</sup>

While shrinkage cracks do not typically affect the structural integrity of concrete masonry buildings, they may sometimes have a negative impact on the aesthetics of a building. In extreme instances, the cracking may diminish the serviceability of a structure by allowing moisture penetration which can lead to corrosion of reinforcing steel. These issues often have a severe financial impact on building owners. Engineers should therefore endeavor to create designs that minimize the amount of cracking that occurs. It is important to understand that while cracking in concrete masonry can be controlled by specifying appropriate materials and correct detailing, it is impossible to guarantee that no cracks will occur. Cracking occurs due to a wide range of factors, some of which are beyond the engineer's control and the goal is not to eliminate cracks completely, but to ensure that the cracks that do occur do not affect the performance or aesthetics of the building during its design life. The most common methods of controlling shrinkage cracks in concrete masonry are as follows:

- Use materials (units, grout and mortar) that have a low shrinkage potential.
- Provide reinforcing steel to resist the tension stresses caused by shrinkage and thus limit the size of the cracks.
- Use control joints that permit movement at selected locations and thereby reduce the tension stresses introduced as the masonry changes volume.

To achieve best results, a combination of all three methods should be used as permitted by the specific project. It should be noted that the IBC and ASTM requirements are typically developed with a life-safety design goal in mind and may not satisfy the aesthetic performance requirements of many projects. It is thus important that engineers work with the

suppliers and contractors to determine the most effective material specifications and construction details when it is important to reduce the amount of cracking.

The materials used for construction of concrete masonry can be specified to minimize the amount of shrinkage and subsequent cracking that may occur. In the past, Type I, moisture-controlled units were specified when it was critical to limit the amount of cracking that occurs. However, the current edition of ASTM C90 has eliminated the designation of Type I and Type II units, which represented moisture controlled and non-moisture controlled units, respectively. This is because of the uncertainty associated with utilization of moisture content alone to determine masonry shrinkage. In addition, it was not always possible to store moisture controlled units at the construction site in a manner that maintained the required moisture content

The masonry strength can also have an impact on the amount of shrinkage cracking. The strength design chapter of TMS 402 code limits the maximum compressive strength of concrete masonry that can be used in design calculations to 4000 psi. However, there is theoretically no limit on the compressive strength of the masonry, or its constituent parts, that are delivered to the job site. The impression is that stronger is better. Since high strength units and grout tend to have more shrinkage and corresponding cracking than low-strength materials, supplying masonry that is significantly stronger than the specified strength could lead to more cracking than expected. Therefore, one approach could be for the engineer to provide limits on the strength of the masonry if cracking is a critical issue in a concrete masonry building.

Horizontal reinforcing steel can also be used to control cracking by resisting the tension stresses induced by the volumetric changes in the concrete masonry. The shrinkage stresses and deformations are not eliminated but distributed more evenly by the resisting steel. Thus, the tendency is to have many small cracks instead of a few large, visible cracks. NCMA TEK 10-1A provides directives for using horizontal steel (with no control joints) to limit the crack widths to 0.02 inches since most waterproofing coatings can effectively resist water penetration when the cracks are of this size. The report recommends the use of horizontal reinforcing steel equal to 0.002 times the net cross-sectional area of the concrete masonry. The use of sufficient amounts of reinforcing steel is sometimes the most cost-effective way to reduce cracking if the aesthetics of the wall are not critical or if the wall is to be covered by a finish material. This is because in seismic regions, a relatively large amount of horizontal steel is already required to resist lateral shear loads on walls.

Another method of crack control is to use control joints that permit movement of the concrete masonry at pre-selected locations in the structure. This is achieved by having a complete break of all materials or by creating weakened planes where cracks are most likely to occur without affecting the building's serviceability or aesthetic features. When not engineered, it is good practice to space control joints no more than 25 feet apart and that the length of each panel created by the control joints does not exceed 1.5 times the wall height, as

shown in Figure 2.4.3. Control joints should also be placed at locations in the building where stress concentrations are expected to occur. Examples of such locations where control joints should be located are shown in Figure 2.4.4. Historically, a control joint is placed on one side of openings that are less than 6 feet wide and on both sides of openings greater than 6 feet wide. Generally, reinforcing steel should be continued through control joints at diaphragm chords and lintels so as to provide the continuity and development length required to transfer loads. Other locations where control joints may be placed include corners of intersecting walls and around pilasters. It is also advisable to locate control joints in line with joints in foundations, floors or roofs so that the movement that occurs at these locations does not result in damage to the concrete masonry.

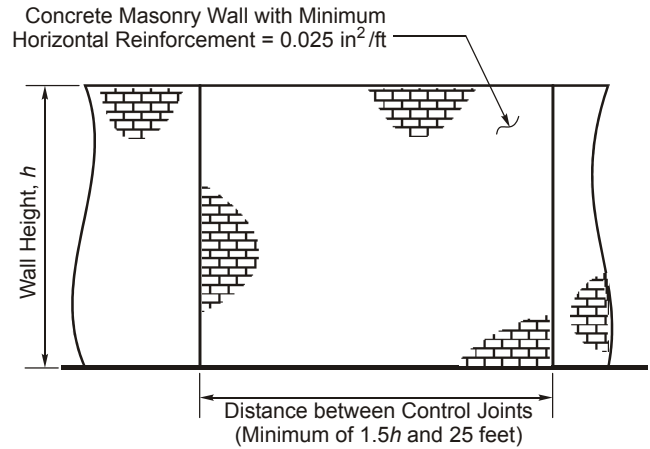

**FIGURE 2.4.3 Recommended Spacing of Control Joints in Concrete Masonry Walls**

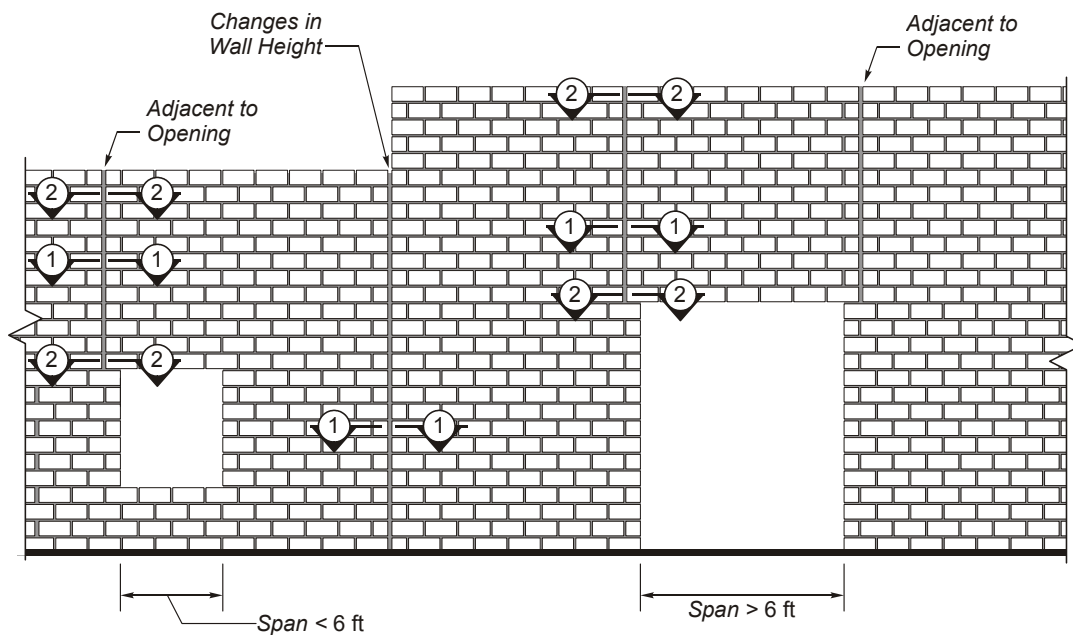

1-1: Typical Condition  
 2-2: Chords and Lintel Condition

**FIGURE 2.4.4 Recommended Spacing of Control Joints in Concrete Masonry Walls**

2.4.3 Types of Control Joints

A common control joint used in the western United States, where seismic design requirements usually require solid-grouted walls, consists of a continuous mortar joint across the height of the wall as shown in Figure 2.4.5. The continuous joint results in a break in the running bond layout of the concrete masonry units. Mortar at the control joint is typically raked back to further weaken the vertical plane so that cracks are more likely to be located at the joint when movement or shrinkage occurs. A sealant is usually applied along the joint to prevent the penetration of moisture into the building through the cracks. Since grout and horizontal reinforcement are continuous, the presence of a control joint does not affect the structural design of the wall and the joint can be used at lintels and chords.

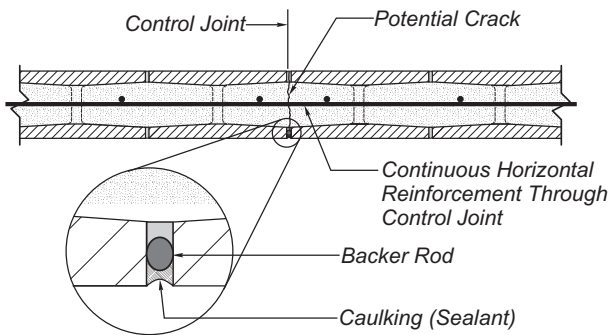
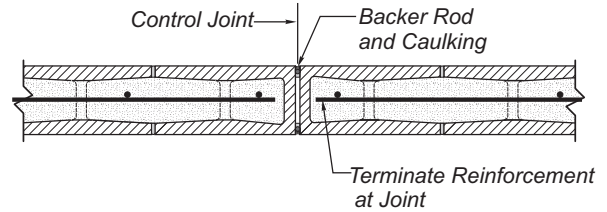

FIGURE 2.4.5 Continuous Control Joint

In some instances, the control joint in Figure 2.4.5 may be modified to allow for more movement by stopping some of the reinforcing steel and weakening the wall even further at the joint. This is typically achieved by terminating every other horizontal reinforcing bar at the joint, except at diaphragm chords and lintels where all steel is continued through the joint. From a structural analysis perspective, the wall can still be considered continuous across the joint if the wall is capable of resisting the applied load with only half of the horizontal reinforcement.

More movement may be accommodated by terminating all materials, including grout and reinforcing steel at a joint, as shown in Figure 2.4.6(a). Such a joint may also be described as an *expansion joint* since it theoretically allows for movement without any cracking at the joint location. The concrete masonry on both sides of the joint should be considered as separate structural elements since there is no physical connection across the joint. When structural continuity is required as in lintels and chords, the grout and reinforcement should be continued across the joint. At these locations the joint acts as the control joint described earlier, with a crack forming when the relative motion occurs between both sides of the joint. A dowel with a plastic sleeve or grease may be used to allow movement but still provide structural continuity as shown in Figure 2.4.6(b). Alternatively, horizontal reinforcement could also be

terminated and the steel ledgers used to connect the floor or roof diaphragms to the concrete masonry designed to act as continuous chords. It should be noted that the continuity of the ledger will limit wall movement and reduce the effectiveness of the joint.



(a) Typical Condition

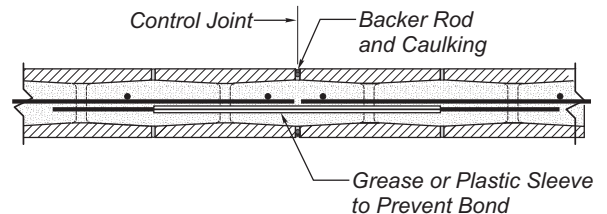

(b) Diaphragm Chord and Lintel Condition

FIGURE 2.4.6 Discontinuous Control Joint

Discontinuous joints are commonly used in partially grouted walls since there is usually no horizontal grouting except at chords and lintels. Figure 2.4.7 shows examples of discontinuous joints in partially grouted concrete masonry. The joint shown may also be used for fully grouted walls.

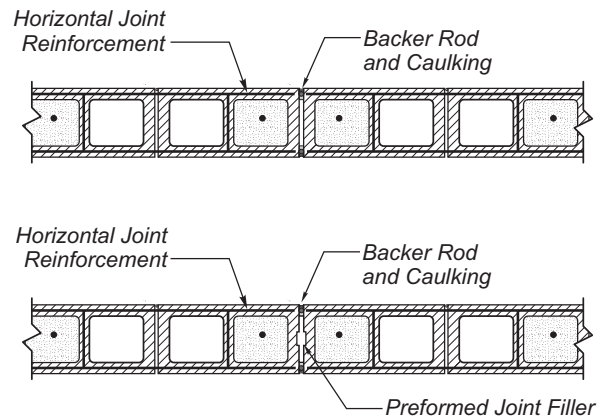

FIGURE 2.4.7 Discontinuous Control Joint in Partially Grouted Walls

## 2.5 FIRE RESISTANCE OF CONCRETE MASONRY

Building codes stipulate fire protection requirements for various types of construction. In multi-family construction for example, a minimum fire protection between units is required to reduce the probability that a fire starting in one unit does not spread to adjacent units in the building. Since concrete masonry is a non-combustible material with superior fire-resistive characteristics, it is an excellent choice for fire separation between units and other locations where fire resistance is required. The typical plan layout of mid-rise residential buildings usually allows these concrete masonry walls to also form part of the gravity and lateral load resisting systems of the building.

As with other building materials, the fire resistance of concrete masonry is based on results from testing of assemblies using ASTM Standard E119, “Standard Test Methods for Fire Tests of Building Construction and Materials”<sup>2.15</sup>. Testing using the standard involves a fire endurance test to determine that an assembly can resist elevated temperatures for the required period without failure, and a hose stream test in which a stream of water is applied to the assembly at a specified pressure and distance from the wall for a specified period. The fire resistive ratings for concrete masonry walls are provided as times over which the assembly satisfies the testing criteria. Table 721.1(2) of the 2012 International Building Code<sup>2.16</sup> provides fire resisting ratings for various types of construction. The ratings for concrete masonry walls and partitions are shown in Table 2.5.1.

**TABLE 2.5.1**  
**Rated Fire Resistive Periods of Concrete Masonry Walls and Partitions**

Type of Aggregate in Concrete Masonry Unit	Minimum Equivalent Effective Thickness Required for Fire Resistance Rating (inches)			
	4 Hr	3 Hr	2 Hr	1 Hr
Expanded slag or pumice	4.7	4.0	3.2	2.1
Expanded clay, shale or slate	5.1	4.4	3.6	2.6
Limestone, cinders or air cooled slag	5.9	5.0	4.0	2.7
Calcareous or siliceous gravel	6.2	5.3	4.2	2.8

As can be seen from Table 2.5.1, the fire resistance ratings of concrete masonry walls depends on the type of aggregate used in the units and the equivalent effective thickness of the wall. When blended aggregates are used for manufacturing the concrete masonry units, the fire resistive period can be obtained by interpolating between the requirements for the

various aggregate types based on the percentage of each aggregate type used.

For fire resistance purposes, the equivalent effective thickness is the thickness of a solid wall that would be obtained if the same amount of material were cast without any voids. The equivalent effective thickness of fully-grouted walls is equal to the specified thickness of the units (i.e. 3/8-inches less than the nominal thickness). The equivalent solid thickness of partially grouted walls is obtained by multiplying the percentage of solids in the block by the specified thickness. The grout in the cells is typically ignored when calculating the fire resistance ratings of partially grouted walls. Table 2.5.2 provides the fire resistance ratings of fully grouted and partially grouted walls that are constructed with units made with calcareous or siliceous gravel aggregates. The fire resistance ratings of walls with units containing other types of aggregate may be obtained by using the values in Table 2.5.1 with the equivalent effective thicknesses in Table 2.5.2. The effective thicknesses are based on typical dimensions of concrete masonry units. Individual block manufacturers may produce units with dimensions that result in slightly different values.

**TABLE 2.5.2**  
**Fire Resistance Ratings for Concrete Masonry Walls Built with Units Made with Calcareous or Siliceous Gravel Aggregates**

Nominal Thickness (inches)	Solid Grouted Masonry		Partially Grouted Masonry	
	Equivalent Effective Thickness (inches)	Fire Resistance Rating	Equivalent Effective Thickness (inches)	Fire Resistance Rating
6	5.6	3 hours	3.1	1 hour
8	7.6	4 hours	4.0	1 hour
10	9.6	4 hours	5.0	2 hour
12	11.6	4 hours	5.7	3 hour

## 2.6 SOUND INSULATION

There are two properties of concrete masonry that make it useful as a noise-controlling material. The first characteristic is its effectiveness as a sound barrier that reflects sound waves. The second property is its ability to absorb sound and further minimize the sound that is transmitted through a concrete masonry wall. As shown in Figure 2.6.1, both of these characteristics combine to make concrete masonry extremely effective in preventing sound transmission over a wide range of frequencies.

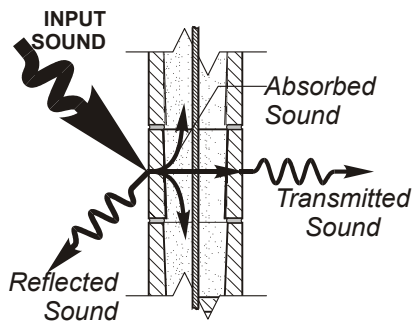

Figure 2.6.1 Noise Reduction with Concrete Masonry Walls<sup>2,17</sup>

Sound absorption is particularly important in auditoriums, concert halls and other locations where noise reflection needs to be minimized to control the sound generated within a room. The sound absorption coefficient defines how effectively a surface absorbs noise. A sound absorption coefficient of 0.25 indicates that 25% of the sound striking the surface is absorbed by the wall at the frequency being considered. The *noise reduction coefficient* (NRC) is the average of the sound absorption coefficient at frequencies of 250, 500, 1000 and 2000 hertz. Table 2.6.1 provides the approximate values of the NRC for some concrete masonry walls. The table shows that lighter material is more efficient in absorbing sound waves. Application of paint and other finishes to concrete masonry typically reduces the NRC value by increasing the amount of sound reflected by the wall.

TABLE 2.6.1 Approximate Noise Reduction Coefficients (NRC) for Unpainted Concrete Masonry Walls

	Surface Texture		
	Coarse	Medium	Fine
Lightweight Concrete Masonry	0.50	0.45	0.40
Normal Weight Concrete Masonry	0.28	0.27	0.26

The challenge of sound insulation is different from sound absorption and is more critical in multi-family residential buildings when compared to other types of structures. In addition to reducing the noise transmitted into the building

interior from exterior sources such as traffic, sirens, etc., there must be sufficient insulation to control the transfer of noise between occupants of adjacent units. Sound control is achieved by minimizing the transmission of sound from one side of a wall to the other by utilizing both the reflective and absorptive characteristics of concrete masonry walls. The ability of concrete masonry to isolate sound in this manner is defined by the *sound transmission class* (STC). ASTM Standard E90, “Standard Test Method for Laboratory Measurement of Airborne Sound Transmission Loss of Building Partition Elements”<sup>2,18</sup>, provides procedures for determining the STC of walls and partitions. The testing involves measuring the decrease in sound energy across a wall for a wide range of frequencies and comparing the results to a standard loss contour.

In lieu of the experimental procedure outlined in ASTM E90, empirical equations have been developed to estimate the STC ratings for various masonry walls. TMS 302, “Standard Method for Determining Sound Transmission Ratings for Masonry Walls”<sup>2,19</sup> provides such relationships. For concrete masonry walls that have a thickness of 3 inches or greater, the STC rating is given by:

$$STC = 20.5W^{0.234} \tag{2.6.1}$$

where  $W$  is the weight of the wall in psf. Unlike sound absorption, the ability of a wall to block sound improves with density. Table 2.6.2 provides the STC values using Equation 2.6.1 for some solid grouted walls constructed with normal weight concrete masonry units. STC values for walls constructed with different weight block, or for walls that are partially grouted may be estimated using the appropriate wall weight and Equation (2.6.1). Building codes generally require that the STC values between living units be no less than 40 to 50.

TABLE 2.6.2 Typical STC Ratings of Solid Grouted Masonry Walls Constructed with Normal Weight Concrete Masonry Units

Nominal Thickness (inches)	Weight (psf)	Calculated STC Rating
6	63	54
8	84	58
10	104	61
12	133	64

When drywall is attached directly to the concrete masonry, the calculated STC rating remains unchanged. However, if 1/2-in or 5/8-inch drywall is attached to a concrete masonry wall using resilient metal furring or a combination of resilient metal furring and wood furring, the increase in the STC rating for drywall on one side of the wall is given by:

$$DSTC = 2.8d - 1.22 \tag{2.6.2}$$



where  $d$  is the thickness of the furring space in inches. For drywall on both sides of the wall the change in STC rating is equal to:

$$\text{DSTC} = 3.6d - 2.78 \quad (2.6.2)$$

Further increases in the STC rating can be obtained by filling the furring space with a sound absorbing material such as cellulose fiber, glass fiber, rock wool insulation or other fibrous material.

## 2.7 ENERGY PERFORMANCE

Concrete masonry has a high thermal mass. This means that it remains cool after air conditioning has been turned off and remains warm after heating has been stopped. This ability to store heat makes buildings constructed with concrete masonry energy-efficient by reducing the heating and cooling demands when compared to other types of construction. It also improves occupant comfort by controlling temperature swings within a building.

On the other hand, since concrete masonry is a highly conductive material, there can be significant heat transfer through walls. In extreme climates, insulation may be used on the interior or exterior of masonry walls to reduce the thermal conductivity. In the moderate climates of the western United States, however, the thermal characteristics of concrete masonry can usually provide excellent thermal performance without the need for additional insulation.

**2.8 REFERENCES**

- 2.1 MSJC, *Building Code Requirements for Masonry Structures (TMS 402-11/ACI 530-11/ASCE 5-11)*, Reported by the Masonry Standards Joints Committee, The Masonry Society, Boulder, Colorado, 2011.
- 2.2 MSJC, *Specification for Masonry Structures (TMS 602-11/ACI 530.1-11/ASCE6-11)*, Reported by the Masonry Standards Joints Committee, The Masonry Society, Boulder, Colorado, 2011.
- 2.3 ASTM, "Standard Methods for Sampling and Testing Concrete Masonry Units and Related Units", Standard C140-14a, Volume 04.05, ASTM International, West Conshohocken, Pennsylvania, 2014.
- 2.4 ASTM, "Standard Test Method for Linear Shrinkage of Concrete Masonry Units," Standard C426-10, Annual Book of ASTM Standards, Volume 04.05, ASTM International, West Conshohocken, Pennsylvania, 2014.
- 2.5 ASTM, "Standard Test Method for Sampling and Testing Grout," Standard C1019-13, Volume 04.05, ASTM International, West Conshohocken, Pennsylvania, 2014.
- 2.6 ASTM, "Standard Test Method for Slump of Hydraulic Cement Concrete," Standard C143/C 143M-12, Volume 04.02, ASTM International, West Conshohocken, Pennsylvania, 2014.
- 2.7 ASTM, "Standard Specification for Mortar for Unit Masonry," Standard C270-12, *Annual Book of ASTM Standards*, Volume 04.05, ASTM International, West Conshohocken, Pennsylvania, 2014.
- 2.8 ASTM, "Standard Test Method for Preconstruction and Construction Evaluation of Mortars for Plain and Reinforced Unit Masonry," Standard C780-14a, *Annual Book of ASTM Standards*, Volume 04.05, ASTM International, West Conshohocken, Pennsylvania, 2014.
- 2.9 ASTM, "Standard Test Method for Compressive Strength of Hydraulic Cement Mortars (Using 2-in. or [50-mm] Cube Specimens)," Standard C109/C 109M-13, Volume 04.01, *Annual Book of ASTM Standards*, ASTM International, West Conshohocken, Pennsylvania, 2014.
- 2.10 ASTM, "Standard Test Method for Compressive Strength of Masonry Prisms" Standard C1314-14, *Annual Book of ASTM Standards*, Volume 04.05, ASTM International, West Conshohocken, Pennsylvania, 2014.
- 2.11 NCMA, "Crack Control in Concrete Masonry Walls," NCMA TEK Report 10-1A, National Concrete Masonry Association, Hendon, Virginia, 2005.
- 2.12 ASTM, "Standard Specification for Load Bearing Concrete Masonry Units," Standard C90-14, *Annual Book of ASTM Standards*, Volume 04.05, ASTM International, West Conshohocken, Pennsylvania, 2014.
- 2.13 Amrhein, J.E., *Reinforced Masonry Engineering Handbook*, 5th Edition, Masonry Institute of America, Los Angeles, California, 1994.
- 2.14 Drysdale, R.G. and Hamid, A.A., *Masonry Structures, Behavior and Design*, The Masonry Society, Boulder, Colorado, 2008.
- 2.15 ASTM, "Standard Test Methods for Fire Tests of Building Construction and Materials," ASTM Standard E119-12a, *Annual Book of ASTM Standards*, Volume 04.07, ASTM International, West Conshohocken, Pennsylvania, 2014.
- 2.16 ICC, *2012 International Building Code*, International Code Council, Inc., Country Club Hills, Illinois, 2012.
- 2.17 NCMA, "Noise Control with Concrete Masonry in Multifamily Housing," NCMA TEK Report 13-2A, National Concrete Masonry Association, Hendon, Virginia, 2007.
- 2.18 ASTM, "Standard Test Method for Laboratory Measurement of Airborne Sound Transmission Loss of Building Partition Elements," Standard E90-09, *Annual Book of ASTM Standards*, Volume 04.06, ASTM International, West Conshohocken, Pennsylvania, 2014.
- 2.19 TMS Standards Development Committee, "Standard Method for Determining Sound Transmission Ratings for Masonry Walls," The Masonry Society, Longmont, Colorado, 2012.