

4x4x16 Solid

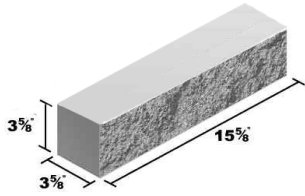

4x8x16x8 L Corner

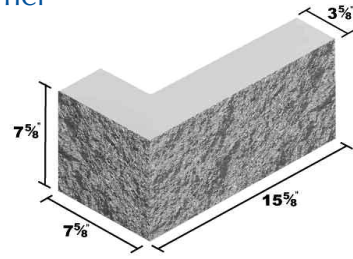

4x8x16 Solid

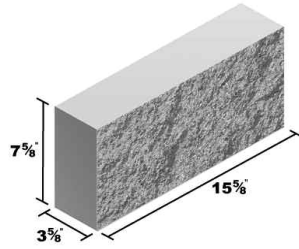

8x4x16 Standard

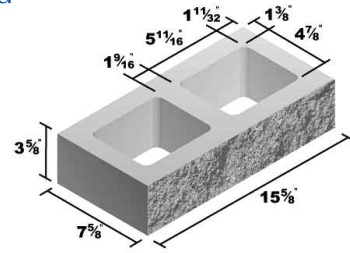

6x8x8 Half

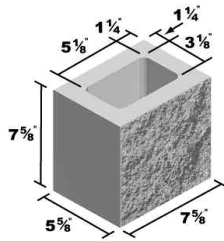

8x8x8 Half

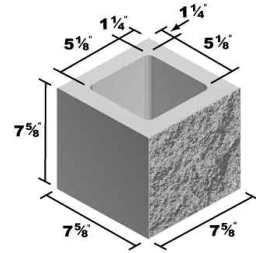

6x8x8 Lintel

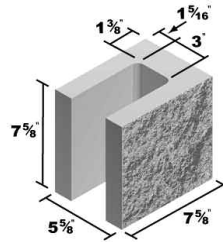

8x8x8 Lintel

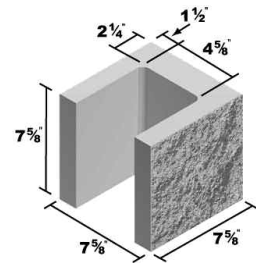

6x8x16 Closed End Bond Beam

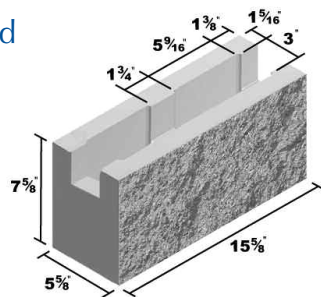

8x8x16 Closed End Bond Beam

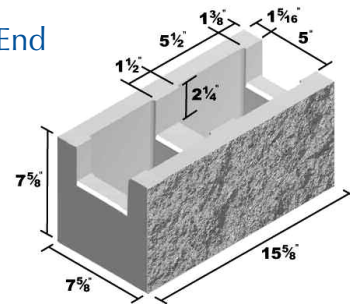

6x8x16 Standard

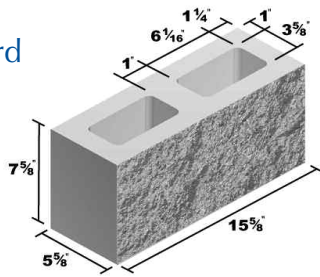

8x8x16 Standard

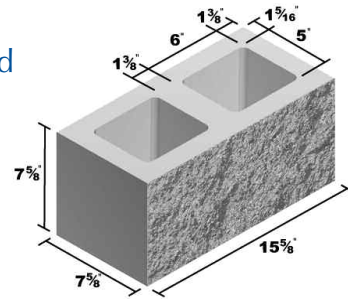

10x4x16 Standard

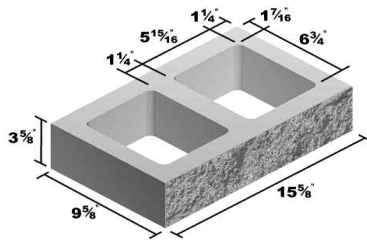

10x8x16 Standard

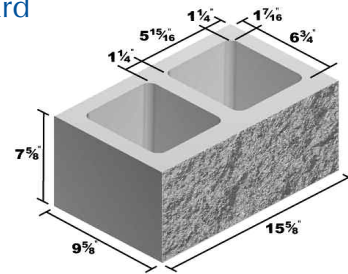

10x8x8 Half

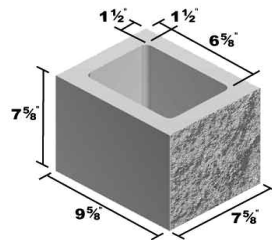

12x4x16 Standard

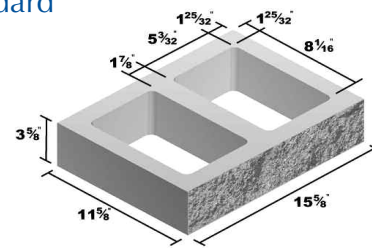

10x8x8 Lintel

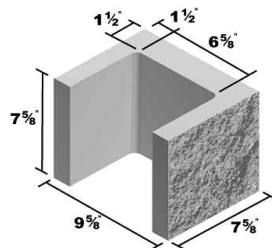

12x8x8 Half

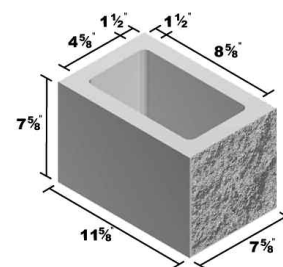

10x8x16 Closed End Bond Beam

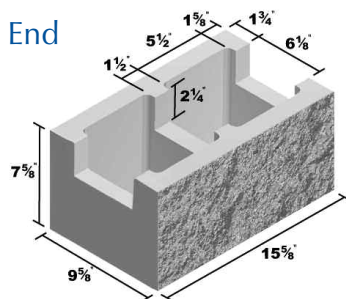

12x8x8 Lintel

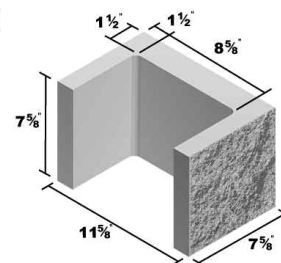

10x8x16 Open End
Bond Beam

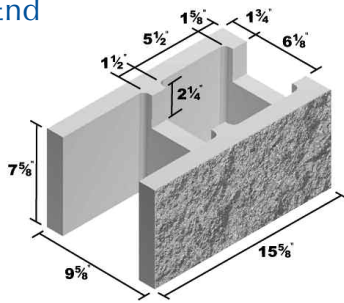

12x8x16 Open End
Bond Beam

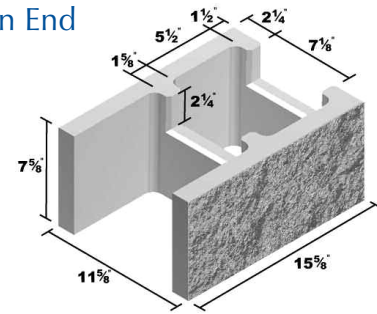

12x8x16 Closed End
Bond Beam

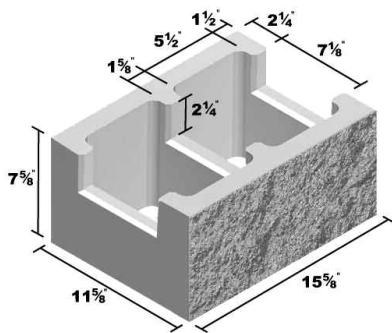

12x8x16 Standard

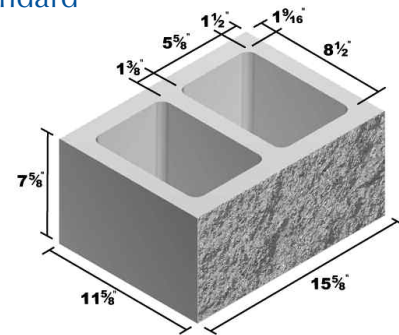

12x8x16 Open End
Standard

