

2x8x16 Solid

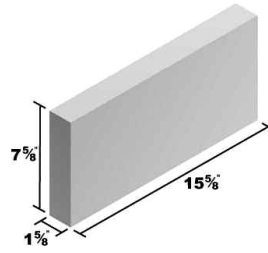

6x8x8 Lintel

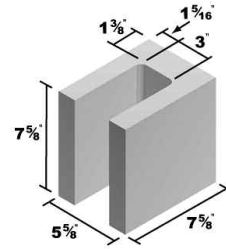

3x8x16 Solid

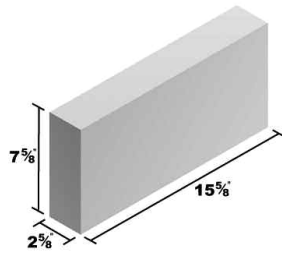

6x8x16 Double Open End Bond Beam

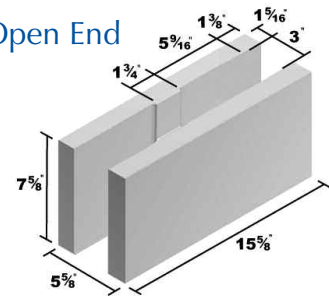

4x8x16 Solid

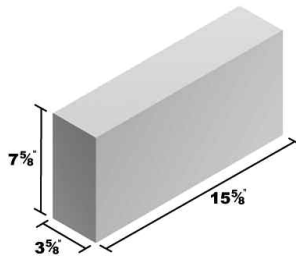

6x8x16 Corner Return

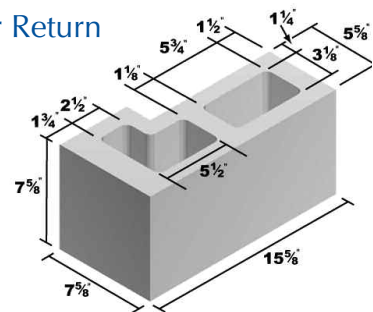

4x8x16 Partition

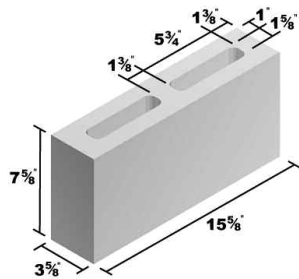

6x8x16 Open End Bond Beam

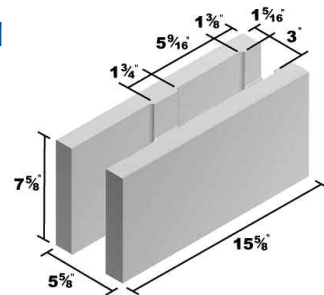

6x8x8 Half

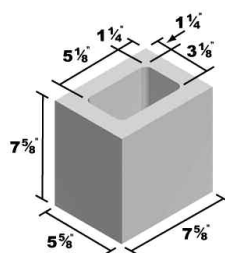

6x8x16 Open End Standard

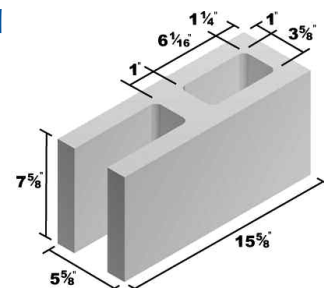

6x8x16 Standard

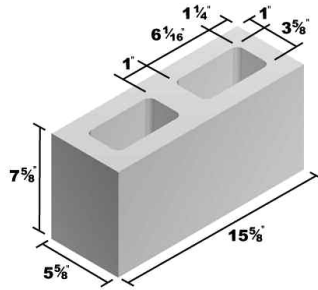

8x8x16 Open End Bond Beam

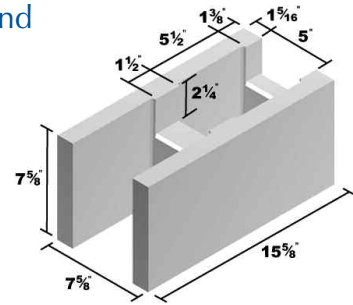

8x4x16 Standard

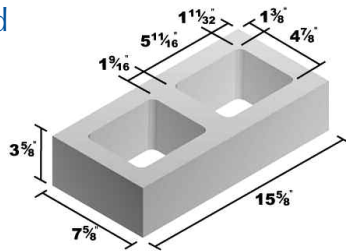

8x8x16 Open End Standard

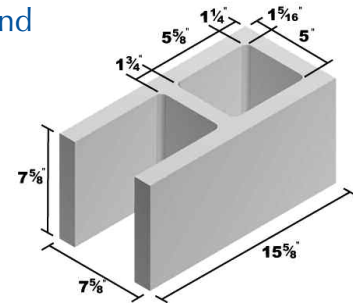

8x8x8 Half

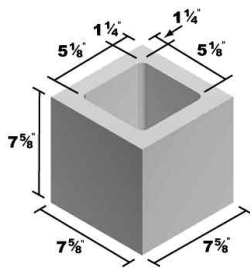

8x8x16 Standard

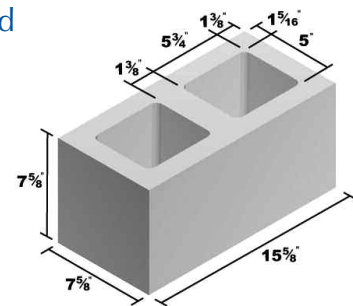

8x8x8 Lintel

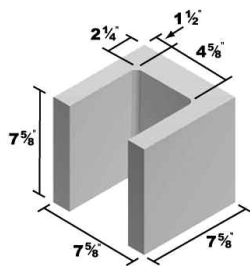

10x4x16 Standard

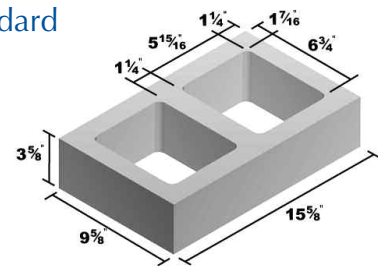

8x8x16 Double Open End Bond Beam

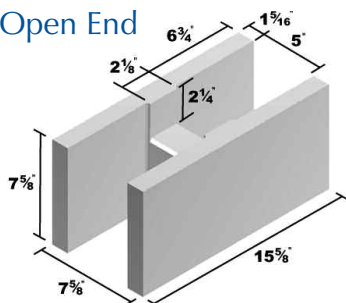

10x8x8 Half

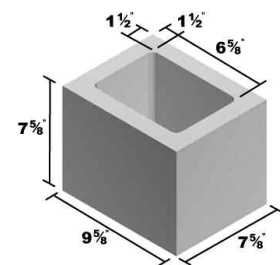

10x8x8 Lintel

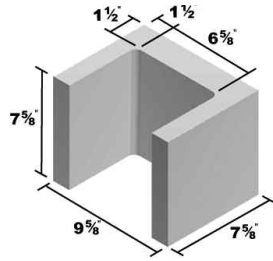

12x4x16 Solid

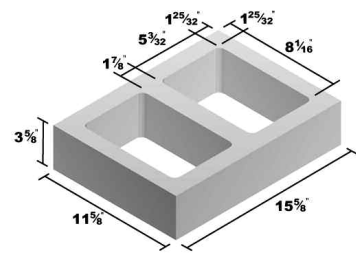

10x8x16 Double Open End Bond Beam

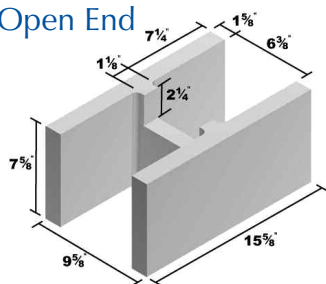

12x8x8 Half

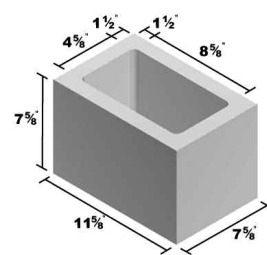

10x8x16 Open End Bond Beam

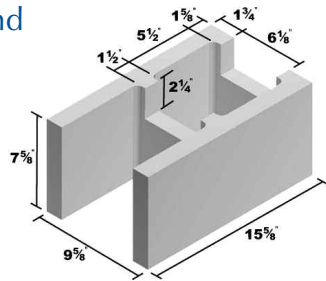

12x8x8 Lintel

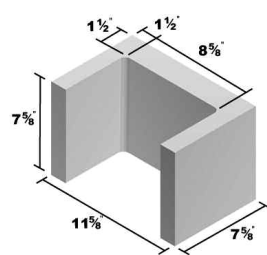

10x8x16 Open End Standard

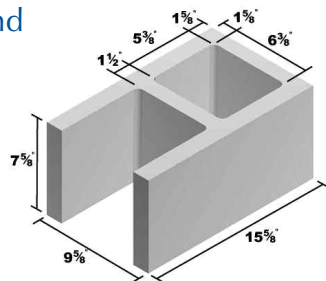

12x8x12 Column

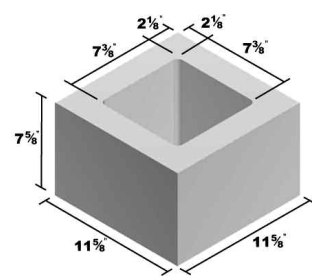

10x8x16 Standard

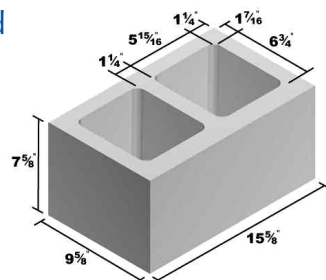

12x8x16 Double Open End Bond Beam

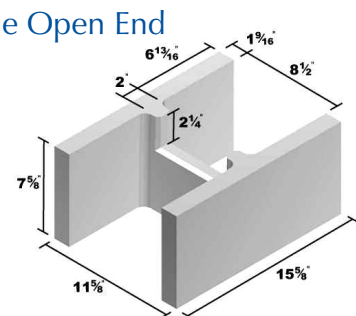

12x8x16 Open End Bond Beam

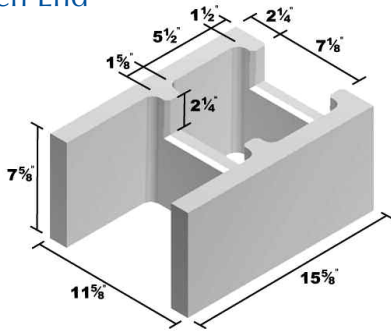

16x8x16 Column

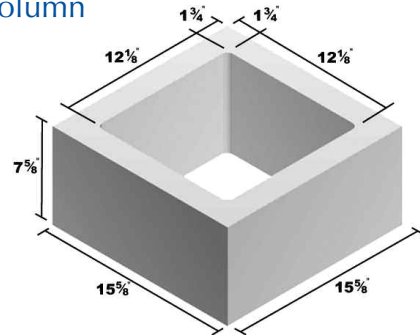

12x8x16 Open End Standard

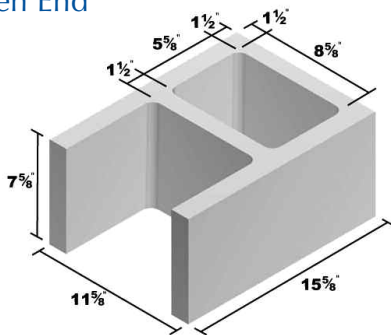

16x8x16 Double Open End Bond Beam

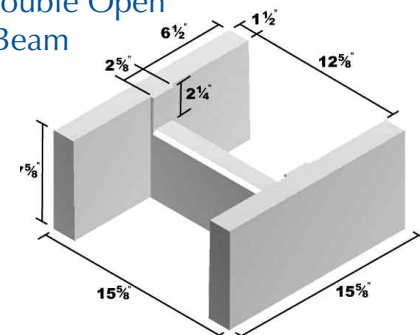

12x8x16 Standard

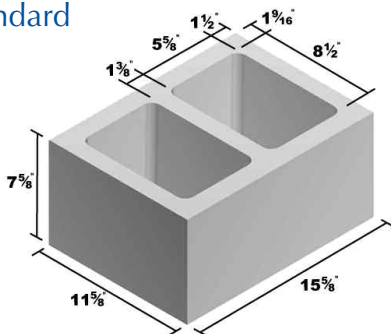

16x8x16 Lintel

