

3x8x16 Solid

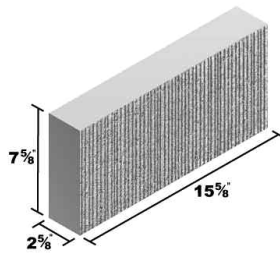

6x8x16 Double Open End Bond Beam

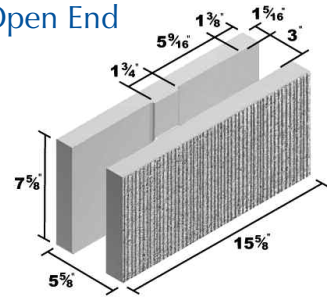

4x8x16 Solid

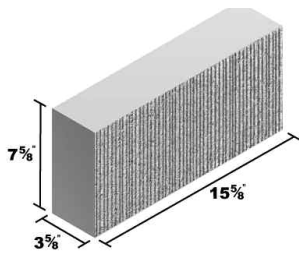

6x8x16 Open End Bond Beam

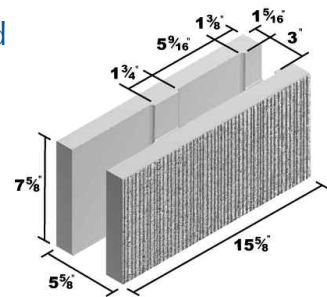

4x8x16 Standard

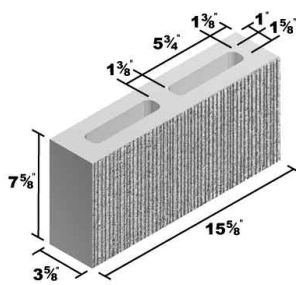

6x8x16 Open End Standard

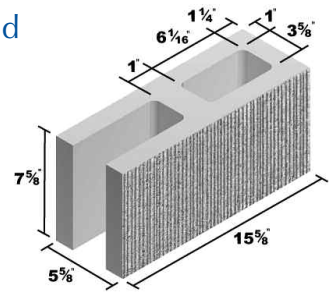

6x8x8 Half

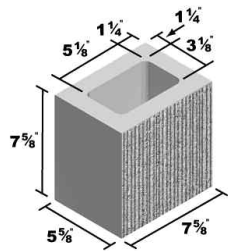

6x8x16 Standard

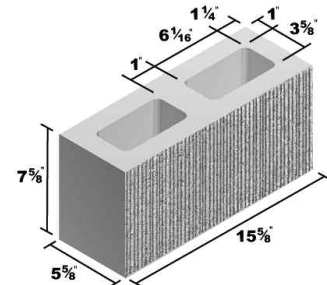

6x8x8 Lintel

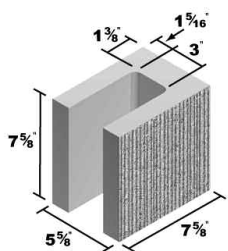

8x4x16 Standard

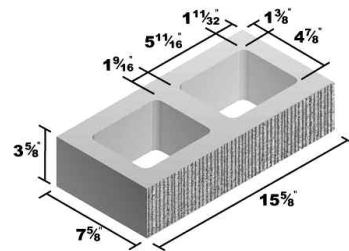

8x8x8 Half

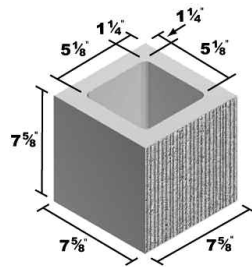

8x8x16 Standard

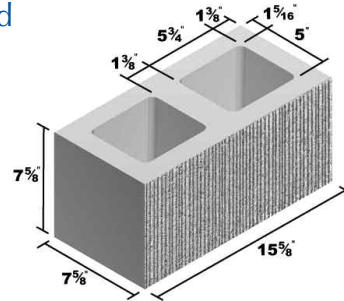

8x8x8 Lintel

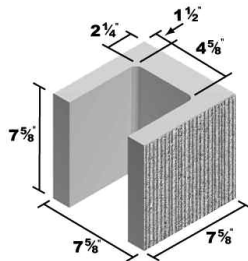

10x4x16 Standard

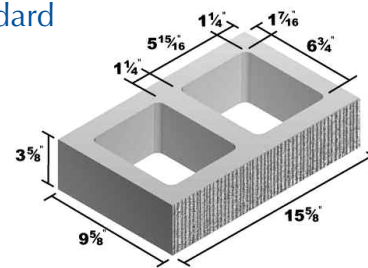

8x8x16 Double Open End Bond Beam

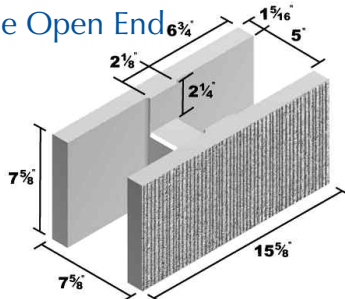

10x8x8 Half

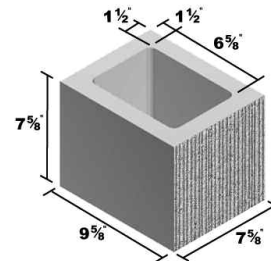

8x8x16 Open End Bond Beam

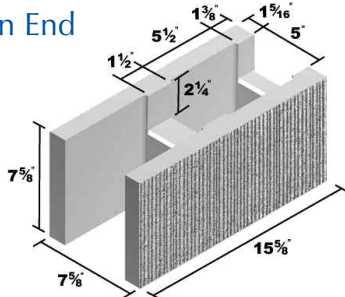

10x8x8 Lintel

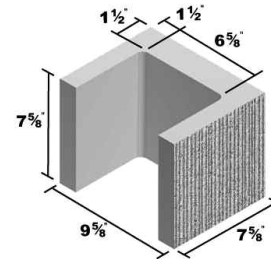

8x8x16 Open End Standard

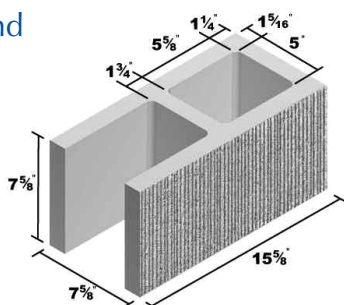

10x8x16 Open End Bond Beam

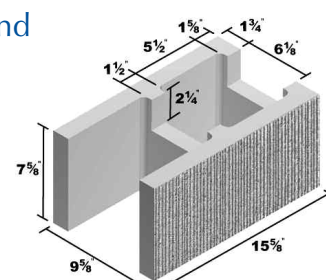

10x8x16 Open End Standard

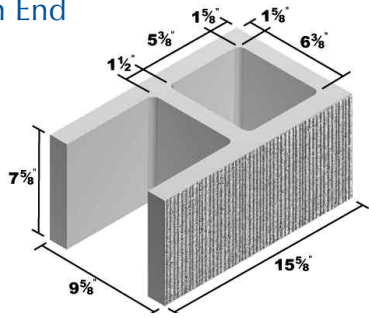

12x8x8 Lintel

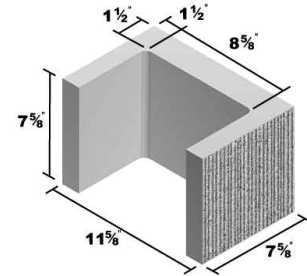

10x8x16 Standard

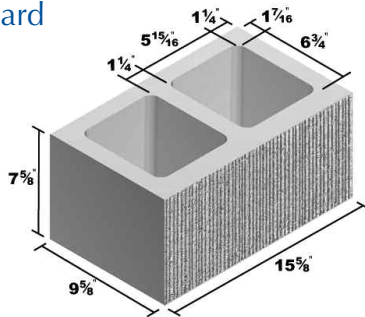

12x8x16 Double Open End Bond Beam

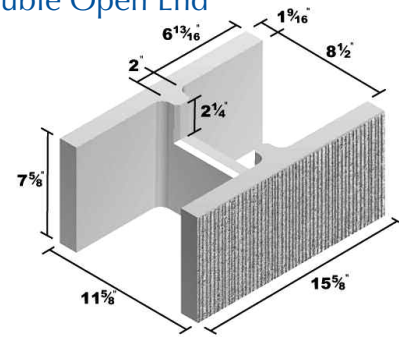

12x4x16 Standard

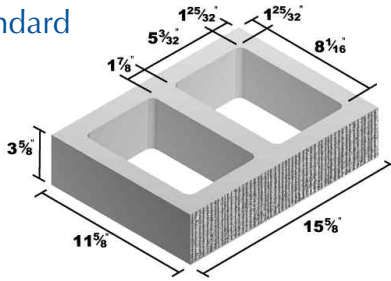

12x8x16 Open End Bond Beam

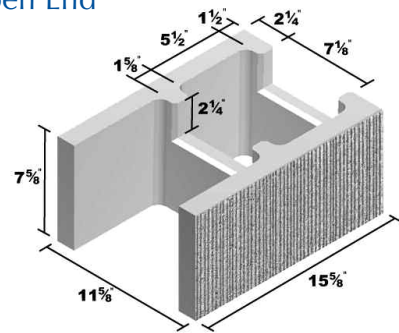

12x8x8 Half

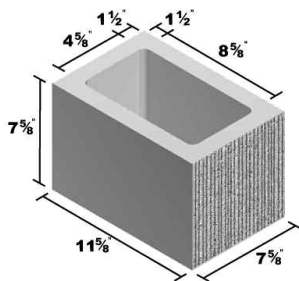

12x8x16 Open End Standard

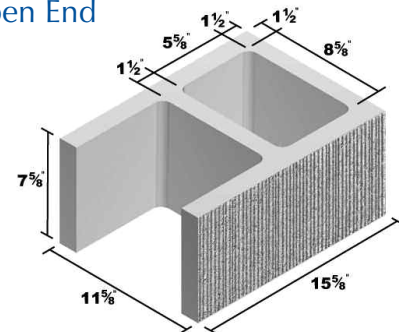

12x8x16 Standard

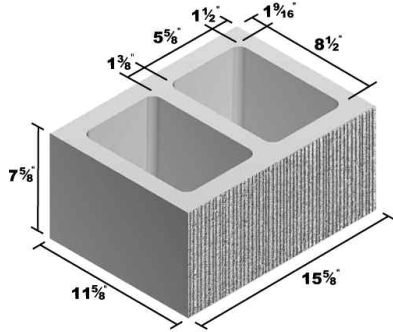

16x8x16 Lintel

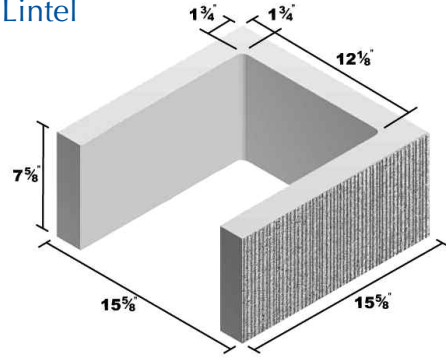

16x8x16 Column

