



ARCHITECTURAL CONCRETE MASONRY

[Serving Washington & Oregon]





Stevens Creek Elementary | Ground Face Charcoal

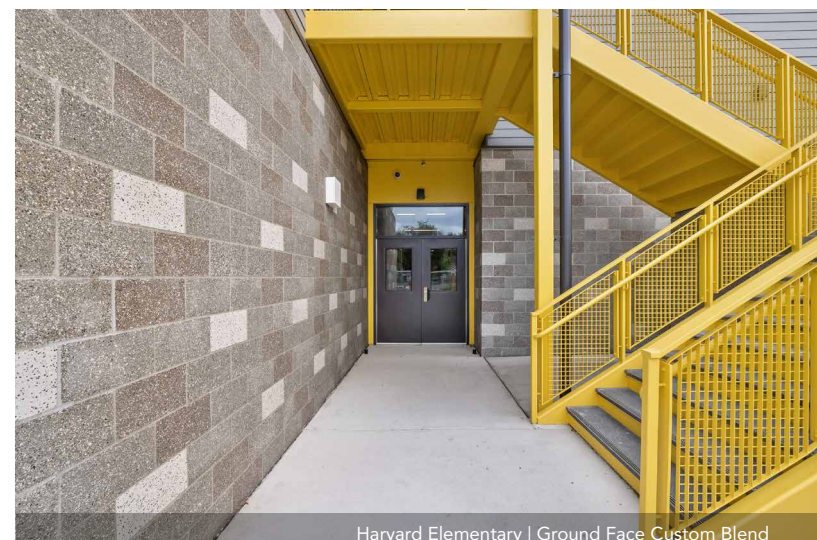

Harvard Elementary | Ground Face Custom Blend

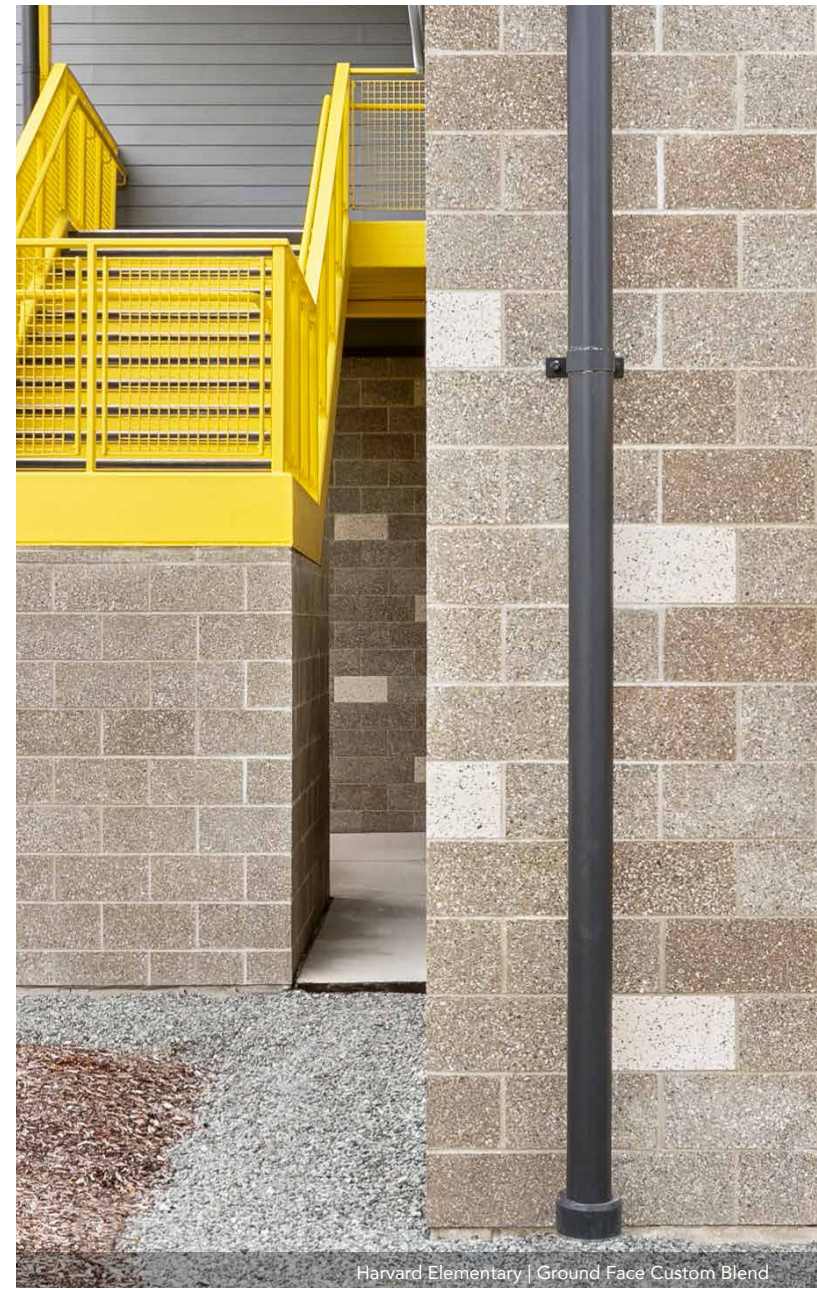

Harvard Elementary | Ground Face Custom Blend

TABLE OF CONTENTS

CMU

ADVANTAGES | 04

SHAPES

ABRI | 06

4-INCH CMU | 07

6-INCH CMU | 07

8-INCH CMU | 08

10-INCH CMU | 09

12-INCH CMU | 09

SPECIALTY CMU | 10

SPECIALTY INSULATION | 11

SPEC-BRIK® | 12

COLORS & TEXTURES

GROUND FACE COLORS | 14

SPLIT FACE COLORS | 15

PRECISION COLORS | 16

MORTAR COLORS | 18

TEXTURES | 19

SPECIFY WITH CONFIDENCE

All our products are manufactured to meet or exceed CMU manufacturing standards for strength and durability. Our commitment to providing high-quality products and excellent customer service will ensure that your project will be customized to your needs.

Meet with one of Basalite's CMU experts to help with your project, from the initial planning stages through final engineering and approval.



REQUEST SAMPLES
Need product samples?
Email dupont.sales@basalite.com or call 253-964-5000 to get your samples



TECHNICAL DOCUMENTS
Looking for data sheets, specifications, Environmental Product Declarations and technical notes? Visit basalite-cmu.com



LOCALLY MADE
Every Basalite CMU is proudly manufactured in our Dupont facility, allowing us to deliver precision-made products to you, wherever and whenever you need them.

CONCRETE MASONRY

CMU HAS MORE ADVANTAGES THAN YOU CAN IMAGINE.

MOISTURE PROTECTION & EFFLORESCENCE CONTROL

When it comes to moisture protection, you can specify an Integral Water Repellent (IWR) in both Basalite® block and mortar. During the manufacturing process we use Integral Water Repellent add mixtures that are mixed throughout the concrete. The IWR increases resistance to wind-driven rain, moisture penetration, and reduces efflorescence.

COLORS & TEXTURES

Turn ordinary into a visual masterpiece by blending Basalite® colors, surface textures, sizes and shapes. We offer a large selection of Standard, Premium and special order colors that are available in Split Face, Ground Face and Precision textures. Speak with your local product expert to get samples.

SHAPES & SIZES

Create unique and memorable design details with Basalite®'s variety of concrete masonry sizes and shapes. From a large 24" long block to specialty sills.

RESILIENCY

Buildings and structures with resilient design and materials can recover quicker following disasters, reduce green house emissions and improve the impacts of a building on the health and performance of occupants. Concrete masonry construction has inherent strength, durability, longevity, fire resistance, seismic and blast resistance all of which contribute to the resiliency of the built environment and can contribute to LEED credits

THERMAL PERFORMANCE

Due to the thermal mass of concrete masonry construction, some energy codes and standards require less insulation in CMU buildings than in equivalent light-frame structures. Although the thermal mass and inherent R-value/U-factor of CMU may be enough to meet energy code requirements (particularly in warmer climates), CMU buildings may need additional insulation. For such conditions, Basalite® offers Korfil insulation inserts. See page 11 for more information.



SHAPES | ABRI

FOR MORE INFORMATION
Contact your local dealer, contractor or
visit basalite-cmu.com

BRING A NEW DIMENSION

ABRI units are available in five shapes and are suitable for vertical or horizontal placement. This opens up a world of possibilities to create unique and fresh wall designs with unexpected profiles and combinations.

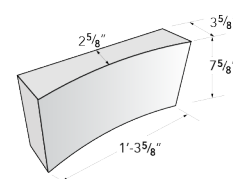
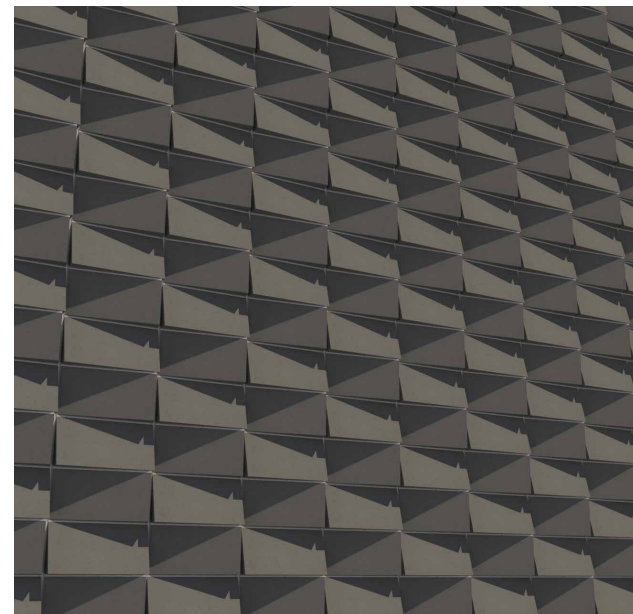
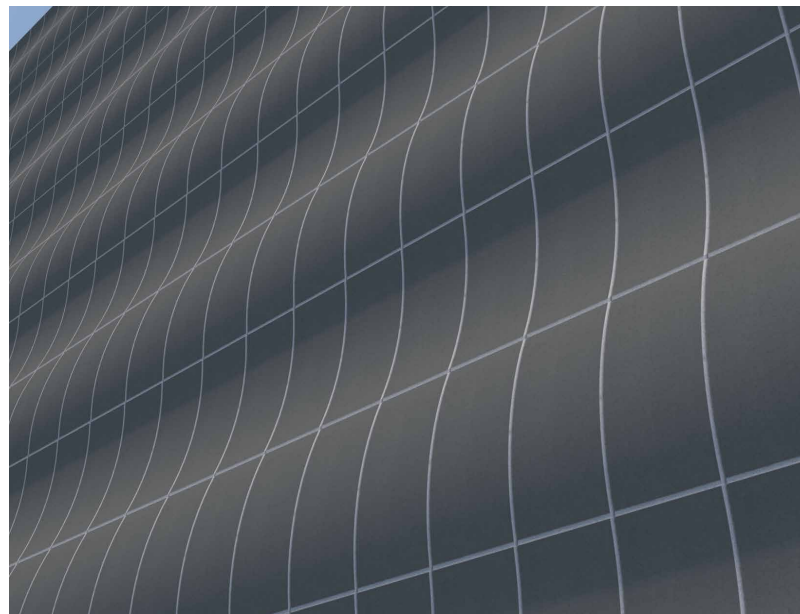

Abri Concave

I | P |

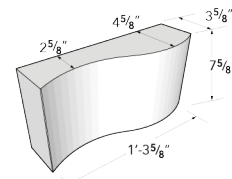

Abri Serpentine

I | P |

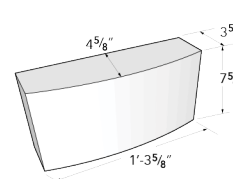

Abri Convex

I | P |

P | PRECISION

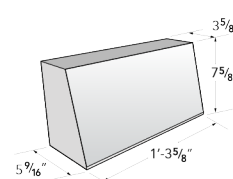

Abri Shingle

I | P |

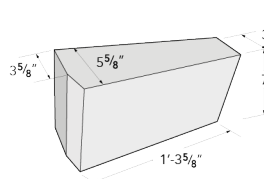

Abri Wedge

I | P |

SHAPES | 4-INCH CMU

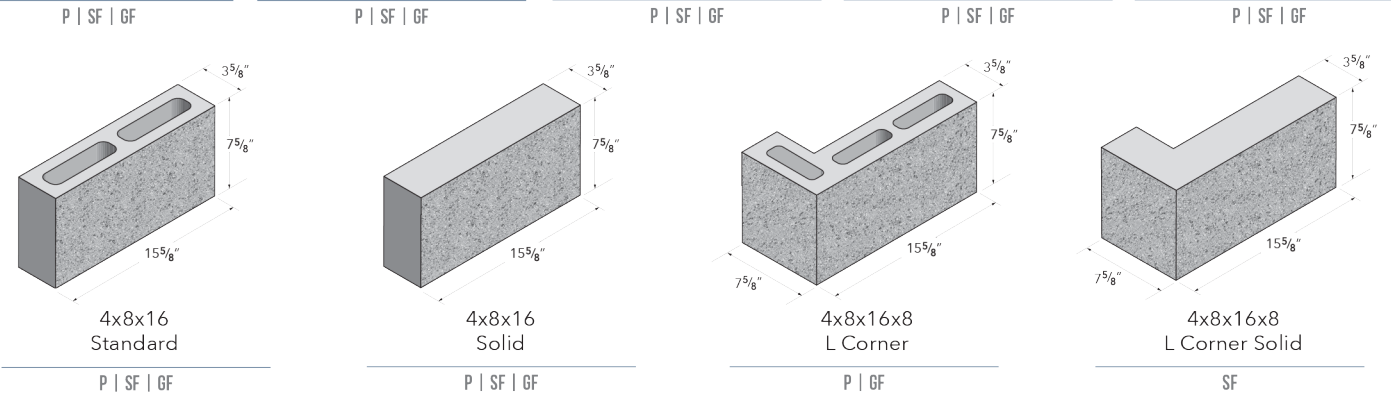
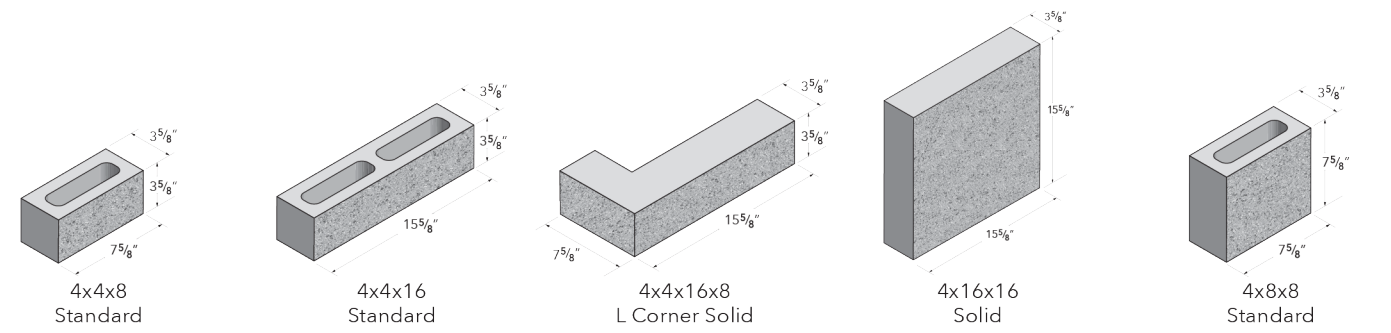

SHAPES | 6-INCH CMU

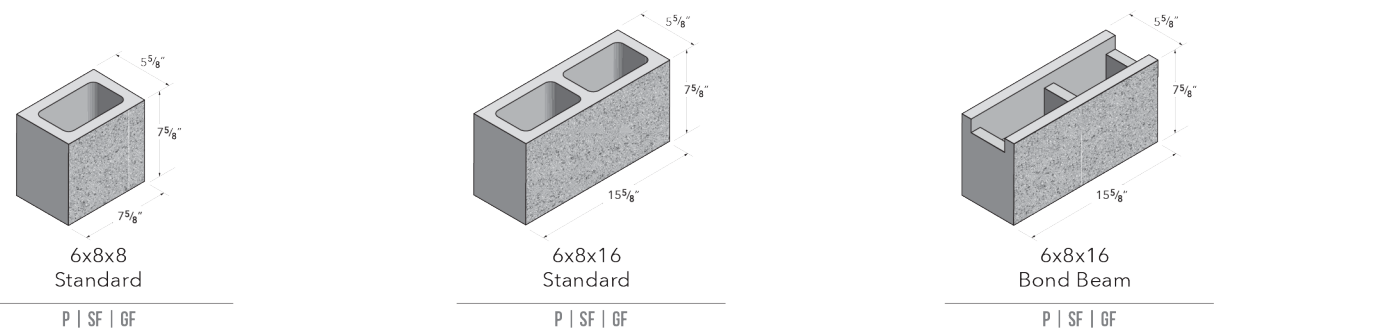
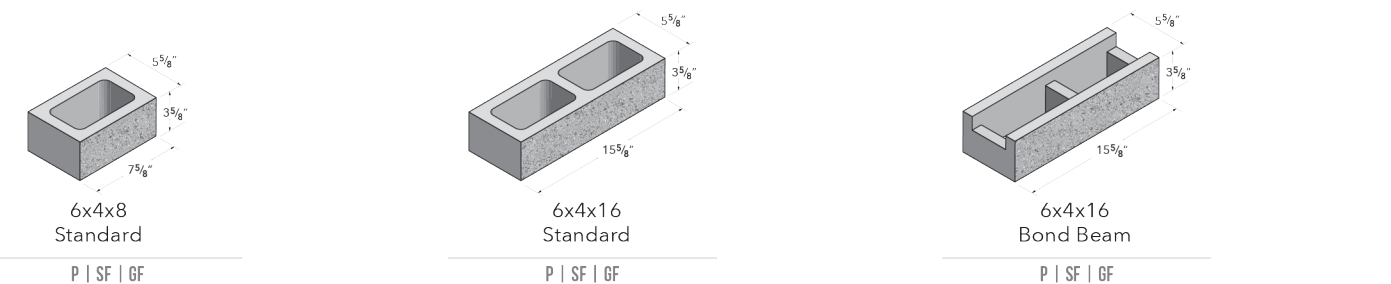

P | PRECISION SF | SPLIT FACE GF | GROUND FACE

SHAPES | 8-INCH CMU

FOR MORE INFORMATION
Contact your local dealer, contractor or
visit basalite-cmu.com

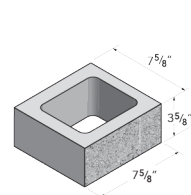

8x4x8
Standard

P | SF | GF

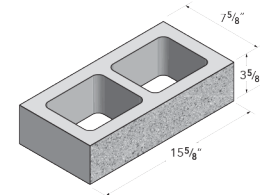

8x4x16
Standard

P | SF | GF

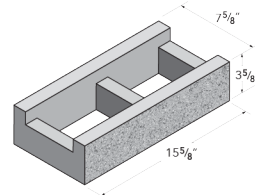

8x4x16
Bond Beam

P | SF | GF

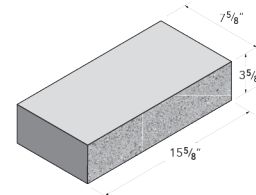

8x4x16
Solid

P | SF | GF

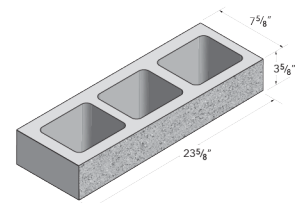

8x4x24
Standard

P | SF | GF

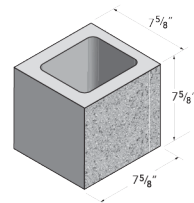

8x8x8
Standard

P | SF | GF

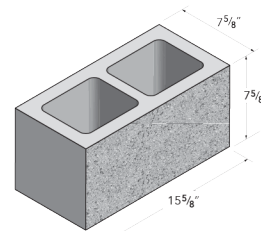

8x8x16
Standard

P | SF | GF

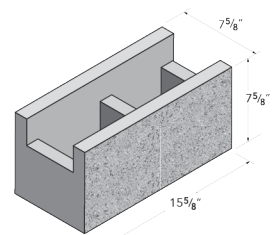

8x8x16
Bond Beam

P | SF | GF

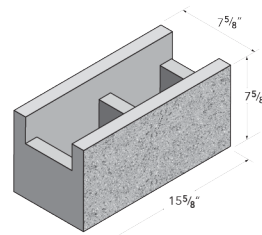

8x8x16
Solid Bottom Bond Beam

P | SF | GF

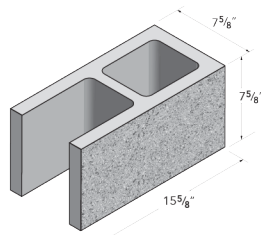

8x8x16
SCOE Block

P | SF | GF

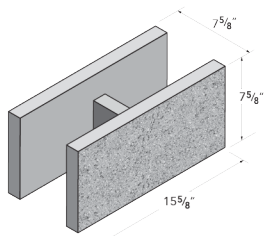

8x8x16
DOE Block

P | SF | GF

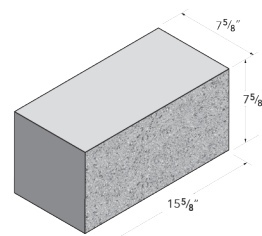

8x8x16
Solid

P | SF | GF

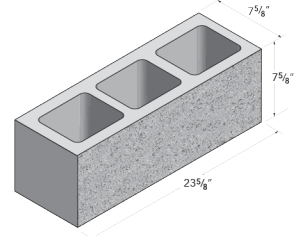

8x8x24
Standard

P | SF | GF

SHAPES | 10-INCH CMU

FOR MORE INFORMATION
Contact your local dealer, contractor or
visit basalite-cmu.com

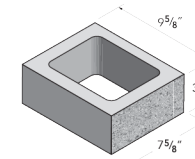

10x4x8
Standard

P | SF | GF

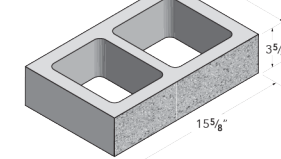

10x4x16
Standard

P | SF | GF

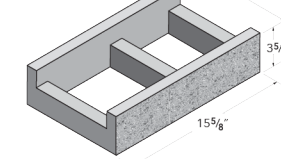

10x4x16
Bond Beam

P | SF | GF

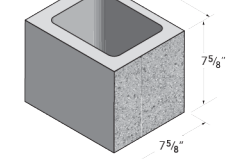

10x8x8
Standard

P | SF | GF

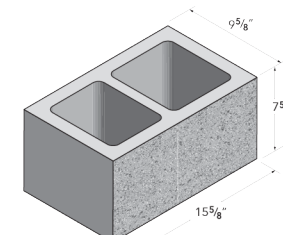

10x8x16
Standard

P | SF | GF

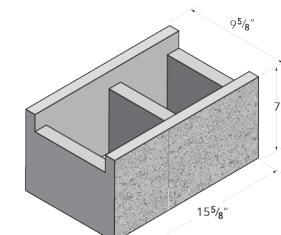

10x8x16
Bond Beam

P | SF | GF

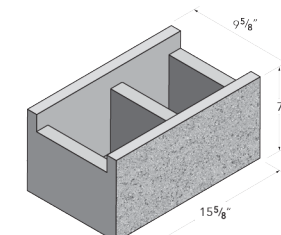

10x8x16
Solid Bottom Bond Beam

P | GF

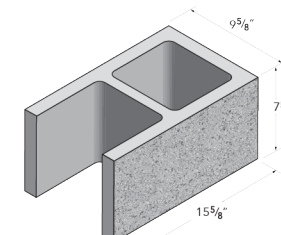

10x8x16
SCOE Block

P | SF | GF

SHAPES | 12-INCH CMU

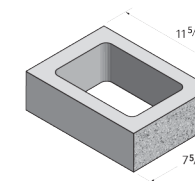

12x4x8
Standard

P | SF | GF

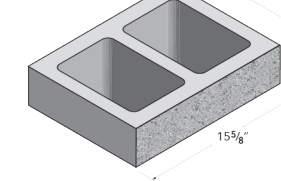

12x4x16
Standard

P | SF | GF

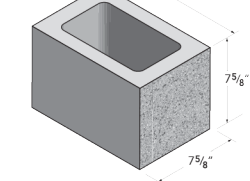

12x8x8
Standard

P | SF | GF

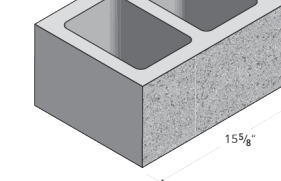

12x8x16
Standard

P | SF | GF

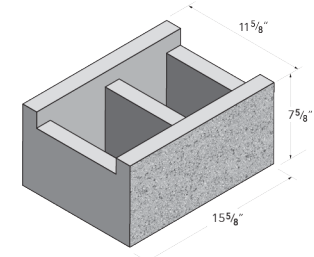

12x8x16
Bond Beam

P | SF | GF

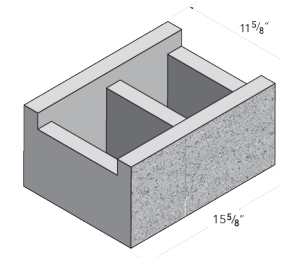

12x8x16
Solid Bottom Bond Beam

P | GF

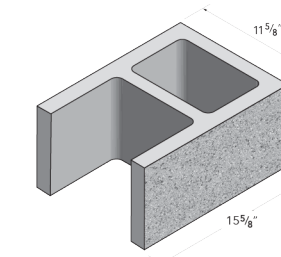

12x8x16
SCOE Block

P | SF | GF

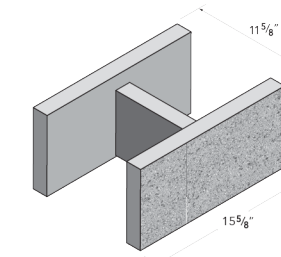

12x8x16
DOE Block

P | SF | GF

P | PRECISION SF | SPLIT FACE GF | GROUND FACE

P | PRECISION SF | SPLIT FACE GF | GROUND FACE

SPECIALTY | CMU

FOR MORE INFORMATION
Contact your local dealer, contractor or
visit basalite-cmu.com

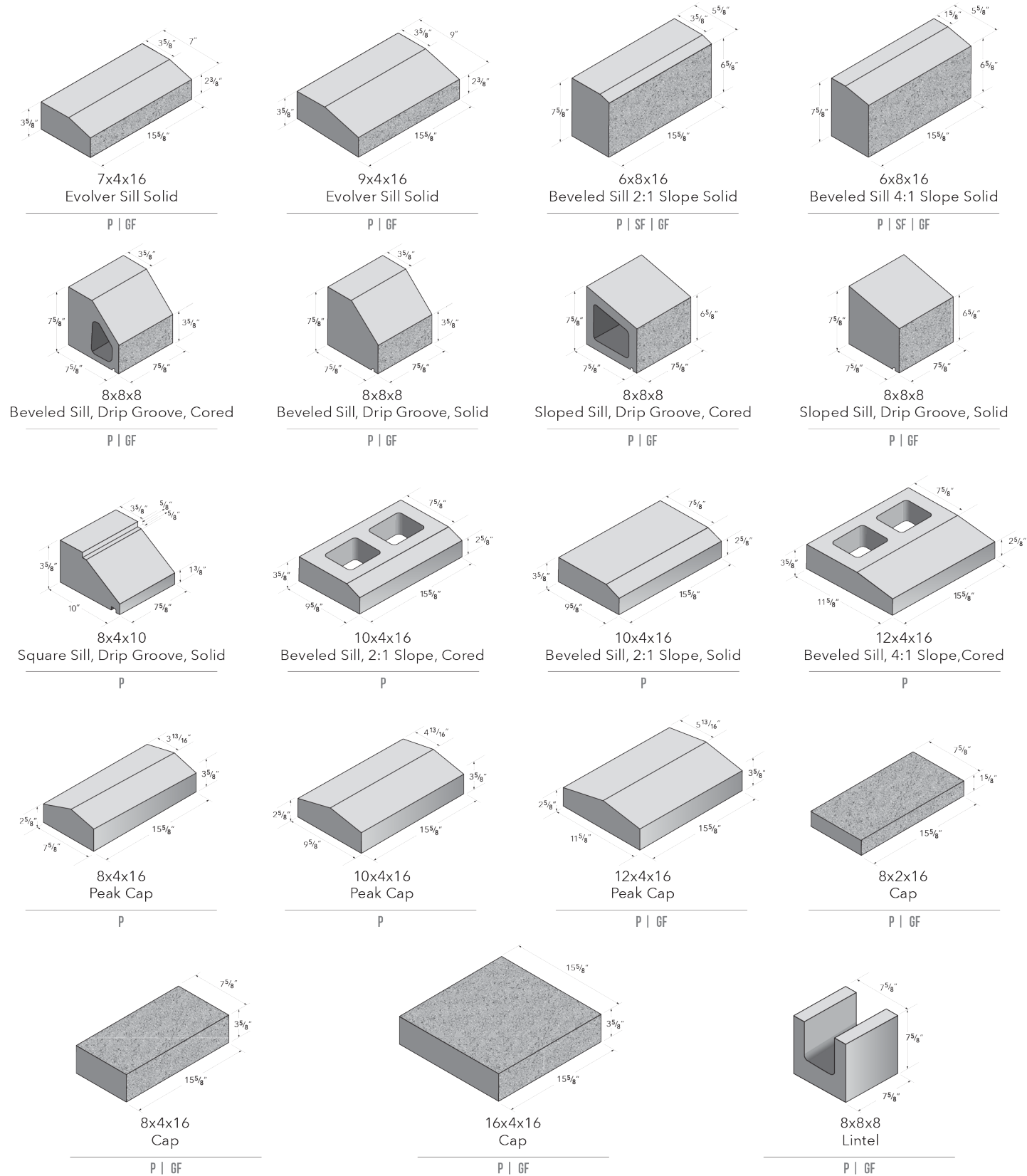

P | PRECISION GF | GROUND FACE

SPECIALTY | INSULATION



ADDED THERMAL PERFORMANCE

Korfil® inserts are individually molded from EPS and are designed to create a wall system capable of achieving higher thermal R values than conventional concrete masonry. Not sure which thermal wall system is right for your project? Call 253-964-5000 for more information.

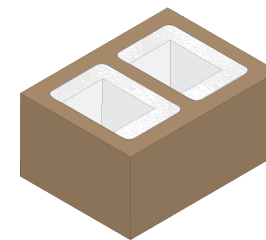
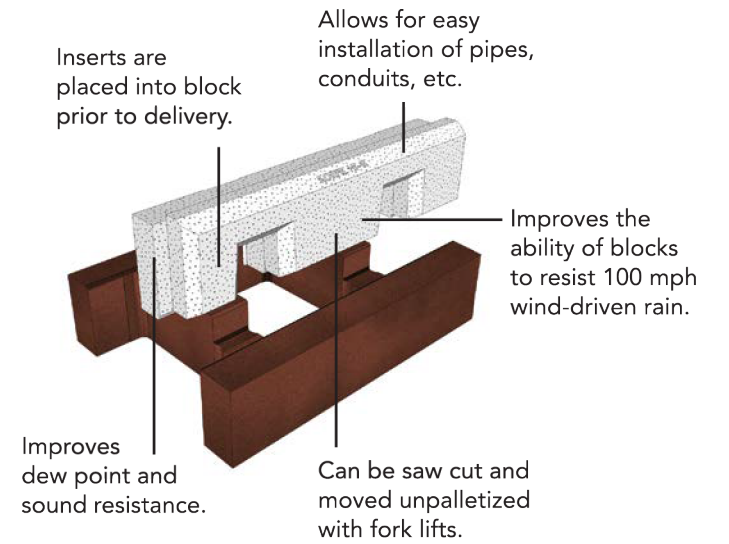

Korfil®

Fits Basalite's 2-core CMU of 6", 8", 10" and 12" widths for use in both single wythe and cavity wall construction.

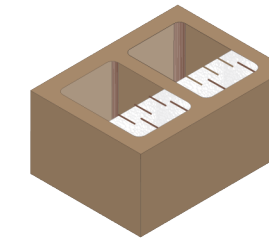

ICON®

Fits Basalite's 2-core CMU. Inserts compress to fit the cores of all masonry units with just one size.

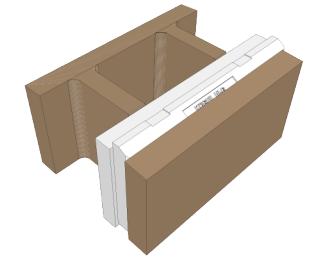

Korfil® Hi-R

Fits Basalite's 2 cross web CMU of 8", 10, or 12" widths. Suitable for fully or partially grouted walls.

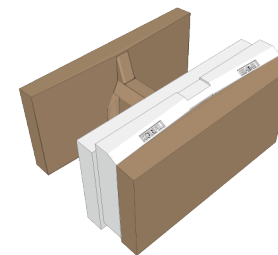

Korfil® Hi-R H

Fits Basalite's 1 cross web masonry units of 12" wide. Suitable for fully grouted walls.



Spec-Brik® Hi-R

This Hi-R insert is designed to fit Spec-Brick units. Suitable for fully or partially grouted walls.

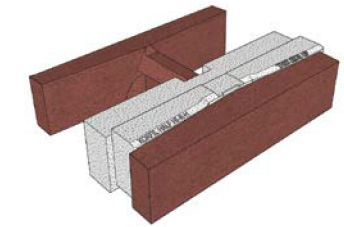

Spec-Brik® Hi-R H

This Hi-R H insulation insert is designed to fit Spec-Brick units. Suitable for fully grouted walls.

SPECIALTY | SPEC-BRIK®

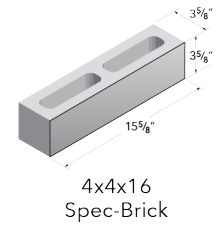

4x4x16
Spec-Brick

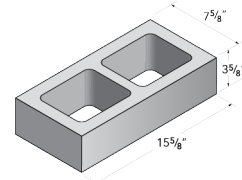

8x4x16
Spec-Brick

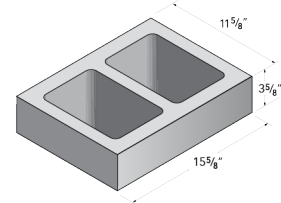

12x4x16
Spec-Brick

COLORS | SPEC-BRIK®

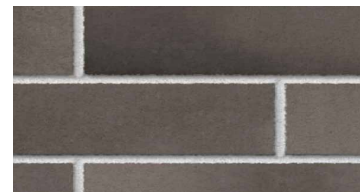

FLINT BLEND



CHESAPEAKE BLEND



DELAWARE BLEND



GARDNER BLEND



HOUSTON BLEND



JEFFERSON CITY BLEND



PHILADELPHIA BLEND



ST. CLOUD BLEND



STANTON BLEND



DIXON BLEND



PANAMA CITY BLEND



BASALT BLEND



COLORS | GROUND FACE

FOR MORE INFORMATION
Contact your local dealer, contractor
or visit basalite-cmu.com

STANDARD COLORS



PREMIUM COLORS



COLORS | SPLIT FACE

FOR MORE INFORMATION
Contact your local dealer, contractor
or visit basalite-cmu.com

STANDARD COLORS

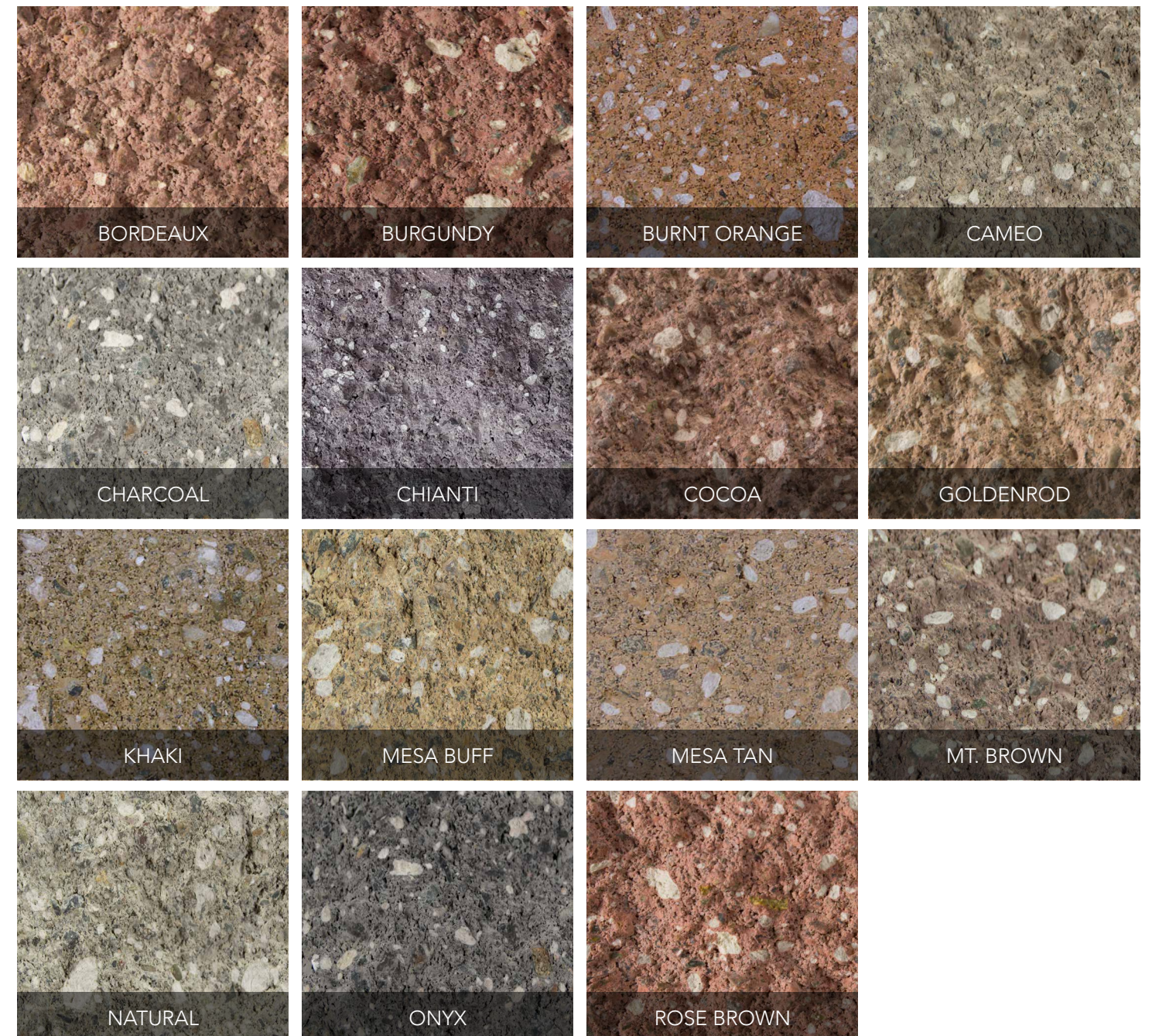

PREMIUM COLORS



COLORS | PRECISION

FOR MORE INFORMATION
Contact your local dealer, contractor
or visit basalite-cmu.com

STANDARD COLORS



PREMIUM COLORS



COLORS | MORTAR

FOR MORE INFORMATION
Contact your local dealer, contractor
or visit basalite-cmu.com

TEXTURES

FOR MORE INFORMATION
Contact your local dealer, contractor
or visit basalite-cmu.com

STANDARD MORTAR COLORS



PREMIUM MORTAR COLORS



ULTRA PREMIUM MORTAR COLORS



Ground Face



Split Face



Precision

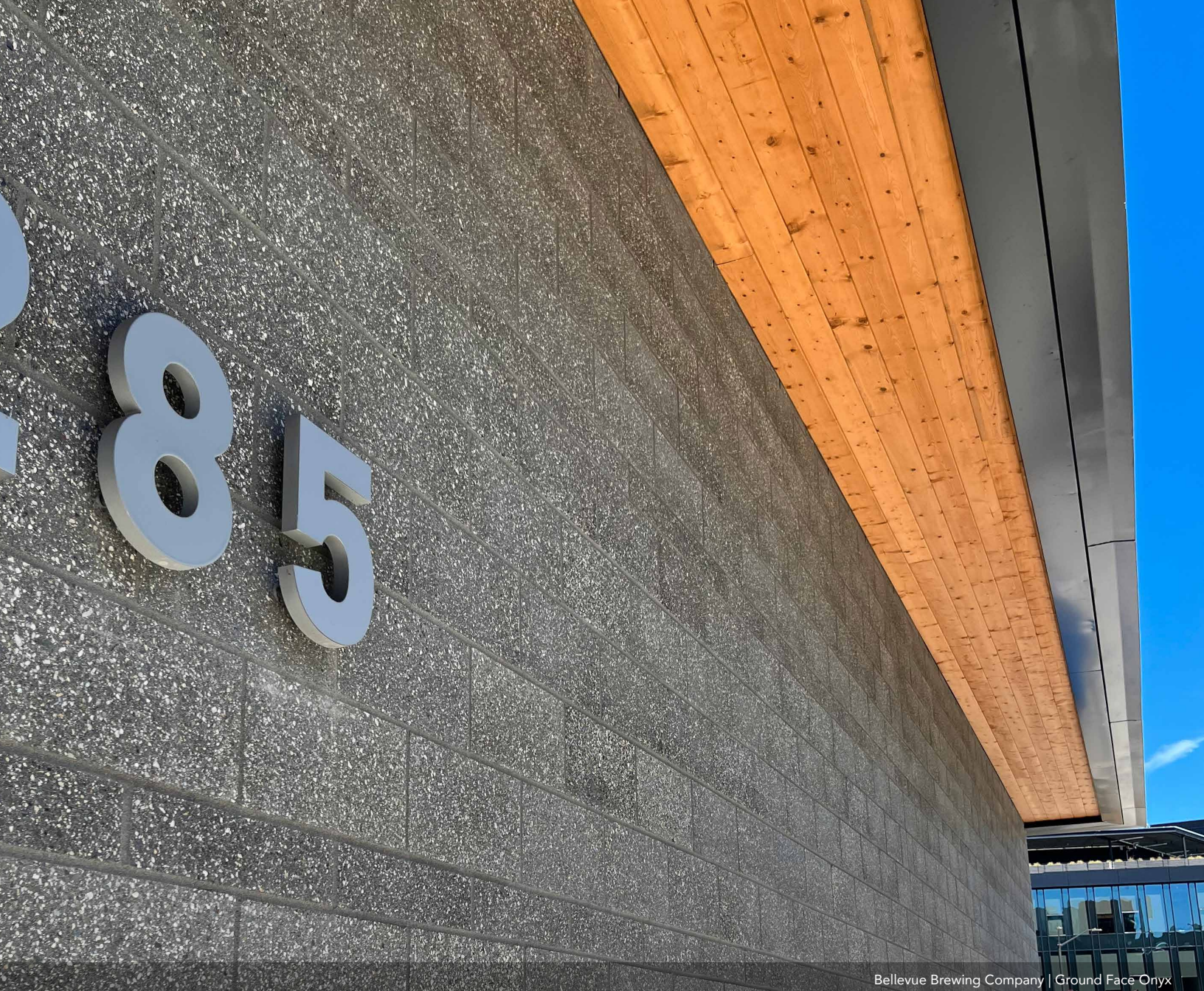

Bellevue Brewing Company | Ground Face Onyx

 **BASALITE**[®]
Concrete Products

3299 International Place
Dupont, WA 98327
253-964-5000

1945 S 1st Street
Redmond, OR 97756
541-548-5910

WWW.BASALITE-CMU.COM

ALBERTA • BRITISH COLUMBIA • CALIFORNIA • COLORADO • IDAHO • NEVADA • OREGON • WASHINGTON

©2024 Basalite® Concrete Products, LLC. All trademarks ® are registered trademarks. (1/17/24-1000)