



Front Cover Red Hawk Ridge Elementary in #869R with #720R Ground Face bands and back cover South Adams County Fire Department





Red Hawk Ridge Elementary in #869R with #720R Ground Face bands

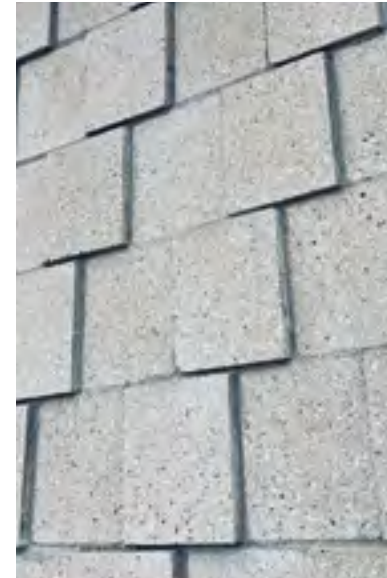

TABLE OF CONTENTS

SHAPES

- BOLD SERIES | 3
- ABRI | 5
- 4 INCH CMU | 6
- 6 INCH CMU | 7
- 8 INCH CMU | 8
- 10 INCH CMU | 9
- 12 INCH CMU | 10

SPECIALTY

- SCREEN BLOCK | 11
- SPEC-BRICK® | 11

TEXTURES

- OPTIONS | 12

COLORS

- GROUND FACE | 13
- SPLIT FACE | 14

SPECIFY WITH CONFIDENCE

All our products are manufactured to meet or exceed CMU manufacturing standards for strength and durability. Our commitment to providing high-quality products and excellent customer service will ensure that your project will be customized to your needs.

Meet with one of Basalite's CMU experts to help with your project, from the initial planning stages through final engineering and approval.

Have questions? Contact us at CMU@basalite.com



REQUEST SAMPLES
Need product samples? Email us at cmu@basalite.com or call 1-800-289-2562 to get your samples.



TECHNICAL DOCUMENTS
Looking for data sheets, specifications, Environmental Product Declarations and technical notes? Visit basalite-cmu.com



LOCALLY MADE
Every Basalite CMU is proudly manufactured in one of our Colorado facilities, allowing us to deliver precision-made products to you, wherever and whenever you need them.

SHAPES | BOLD SERIES

For texture availability please refer to the letter designation under each shape.

MAKE A BOLD STATEMENT

The Basalite® Bold series is a large scale CMU available in a variety of sizes, textures and colors. This oversized unit allows for minimal grout lines

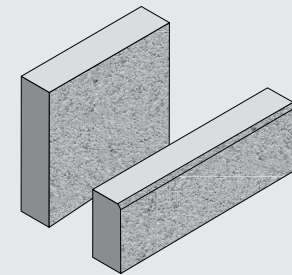

while providing a smooth and cohesive appearance, which makes it perfect for sleek and modern designs.

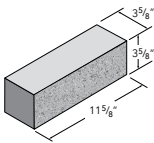
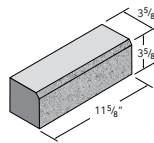
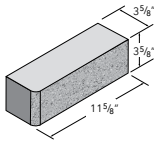
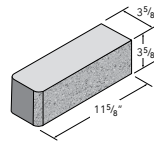
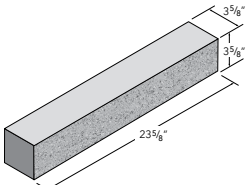
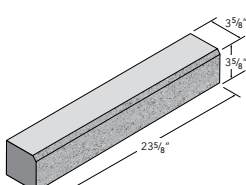
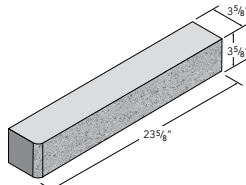
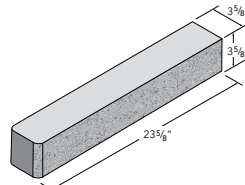
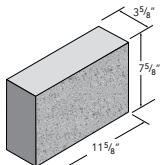
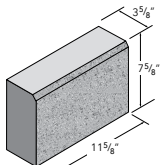
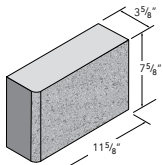
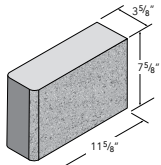
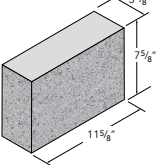
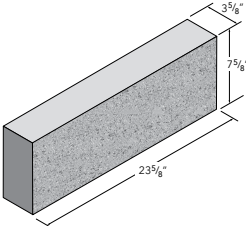
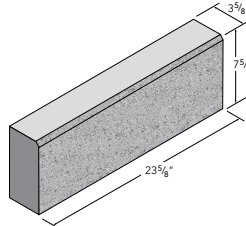
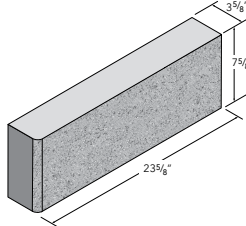
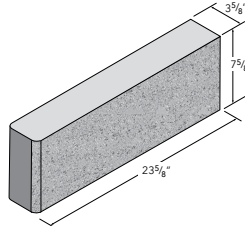
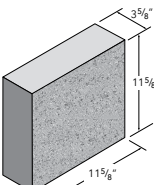
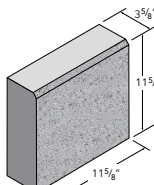
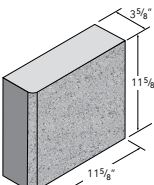
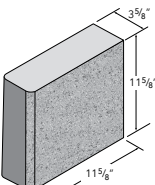
 4x4x12 Solid C SF GF SBL GFS	 4x4x12 Solid Chamfer GF SBL GFS	<p>The Basalite® Bold series is a large scale CMU available in a variety of sizes, textures and colors. This oversized unit allows for minimal grout lines while providing a smooth and cohesive appearance, which makes it perfect for sleek and modern designs.</p>		
 4x4x12 Single Bullnose P GF SBL GFS	 4x4x12 Double Bullnose P GF SBL GFS			
 4x4x24 Solid P C SF GF SBL GFS	 4x4x24 Solid Chamfer P GF SBL GFS	 4x4x24 Single Bullnose P GF SBL GFS	 4x4x24 Double Bullnose P GF SBL GFS	
 4x8x12 Solid P C SF GF SBL GFS	 4x8x12 Solid Chamfer P GF SBL GFS	 4x8x12 Single Bullnose P GF SBL GFS	 4x8x12 Double Bullnose P GF SBL GFS	 4x8x12 1 face 1 End P C SF GF SBL GFS
 4x8x24 Solid P C SF GF SBL GFS	 4x8x24 Solid Chamfer P GF SBL GFS	 4x8x24 Single Bullnose P GF SBL GFS	 4x8x24 Double Bullnose P GF SBL GFS	
 4x12x12 Solid GF SBL GFS	 4x12x12 Solid Chamfer GF SBL GFS	 4x12x12 Single Bullnose GF SBL GFS	 4x12x12 Double Bullnose GF SBL GFS	

P | Precision C | Comb SF | Split Face GF | Ground Face SBL | Shot Blast GFS | Ground Face Shot Blast

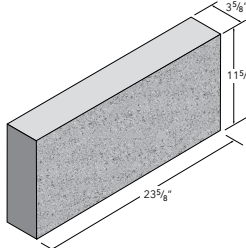
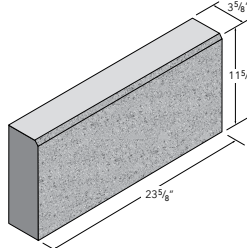
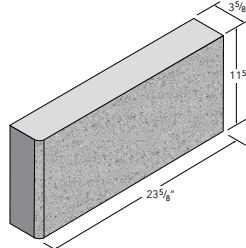
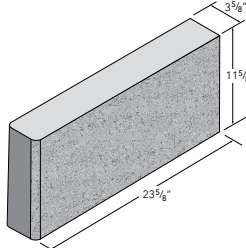
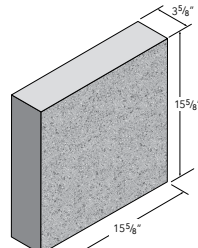
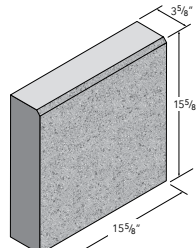
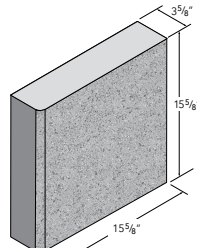
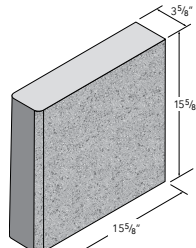
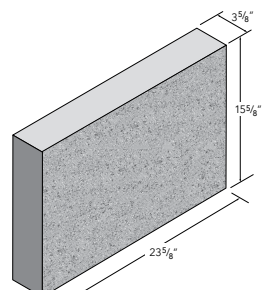
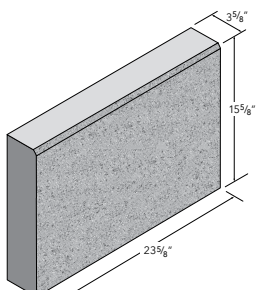
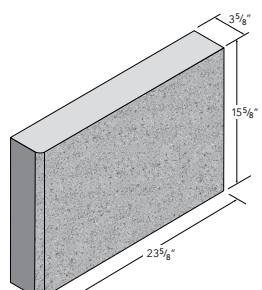
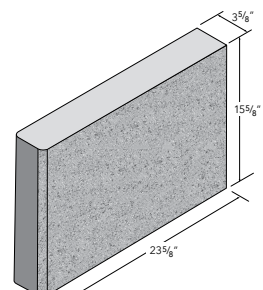
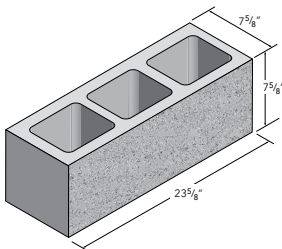
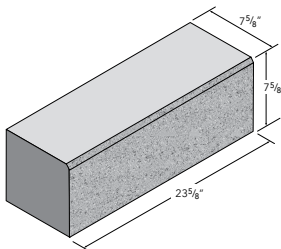
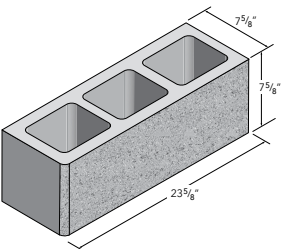
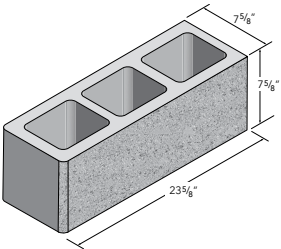
 4x12x24 Solid GF SBL GFS	 4x12x24 Solid Chamfer GF SBL GFS	 4x12x24 Single Bullnose GF SBL GFS	 4x12x24 Double Bullnose GF SBL GFS
 4x16x16 Solid GF SBL GFS	 4x16x16 Solid Chamfer GF SBL GFS	 4x16x16 Single Bullnose GF SBL GFS	 4x16x16 Double Bullnose GF SBL GFS
 4x16x24 Solid GF SBL GFS	 4x16x24 Solid Chamfer GF SBL GFS	 4x16x24 Single Bullnose GF SBL GFS	 4x16x24 Double Bullnose GF SBL GFS
 8x8x24 Standard P C SF GF SBL GFS	 8x8x24 Solid Chamfer P C SF GF SBL GFS	 8x8x24 Single Bullnose P GF SBL GFS	 8x8x24 Double Bullnose P GF SBL GFS

NEW SIZE
COMING IN
2021

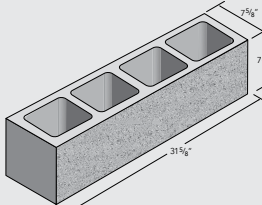
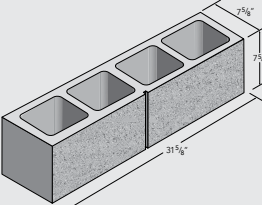
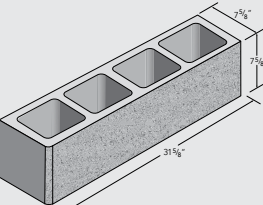
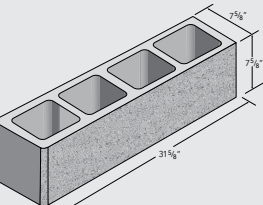
 8x8x32 Standard P GF SBL GFS	 8x8x32 Single Score P GF SBL GFS	 8x8x32 Single Bullnose P GF SBL GFS	 8x8x32 Double Bullnose P GF SBL GFS
---	---	--	--

P | Precision C | Comb SF | Split Face GF | Ground Face SBL | Shot Blast GFS | Ground Face Shot Blast

SHAPES | ABRI

For texture availability please refer to the letter designation under each shape.

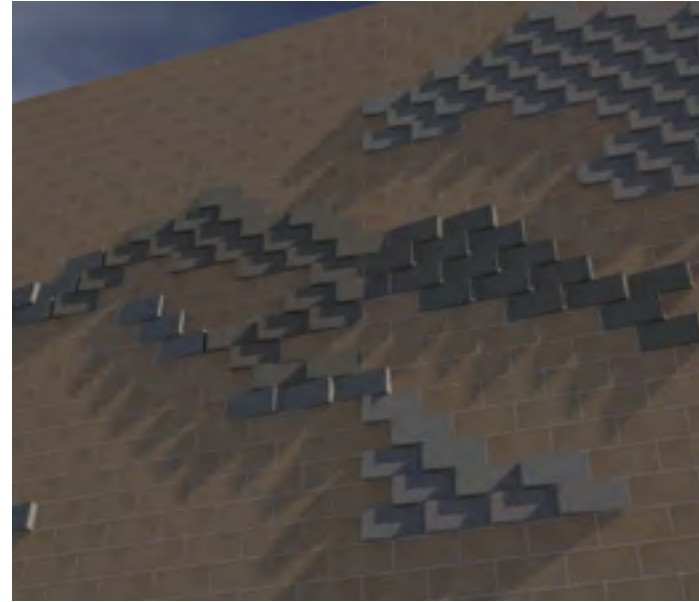

BRING A NEW DIMENSION

ABRI units are available in five shapes and are suitable for vertical or horizontal placement. This opens up a world of possibilities to create unique and fresh wall designs with unexpected profiles and combinations.

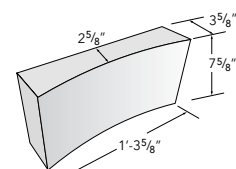
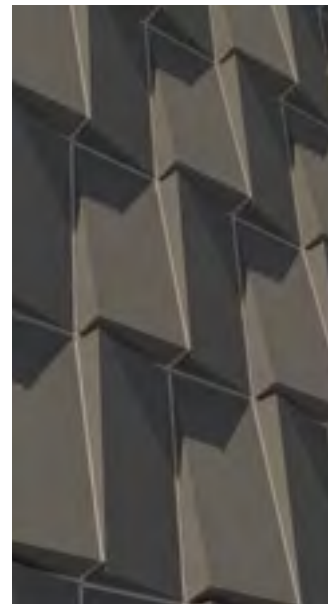
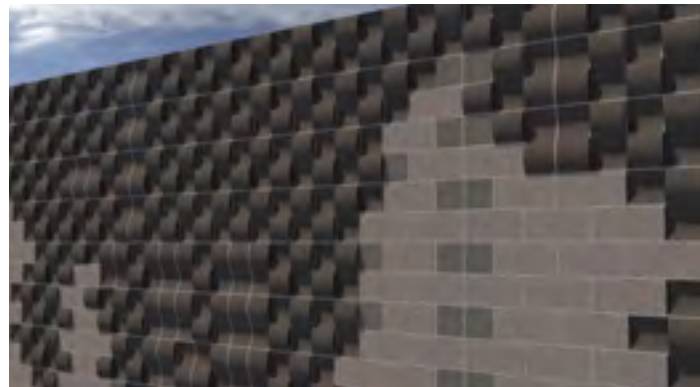

Abri Concave

P

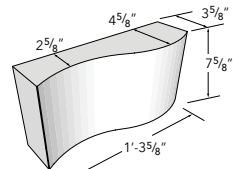

Abri Serpentine

P

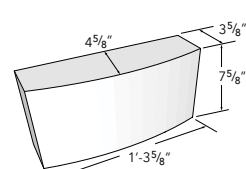

Abri Convex

P

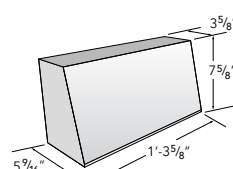

Abri Shingle

P

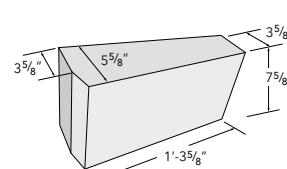

Abri Wedge

P

P | Precision C | Comb SF | Split Face GF | Ground Face SBL | Shot Blast GFS | Ground Face Shot Blast

SHAPES | 4 INCH CMU

For texture availability please refer to the letter designation under each shape.

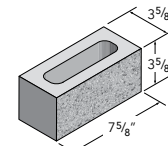

4x4x8 Standard

P | C | SF | GF | SBL | GFS

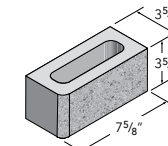

4x4x8 Single Bullnose

P | GF | SBL | GFS

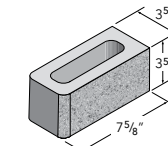

4x4x8 Double Bullnose

P | GF | SBL | GFS

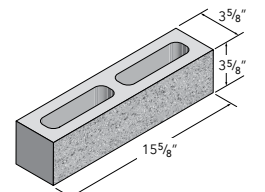

4x4x16 Standard

P | C | GF | SBL | GFS

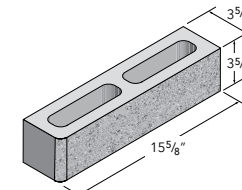

4x4x16 Single Bullnose

P | GF | SBL | GFS

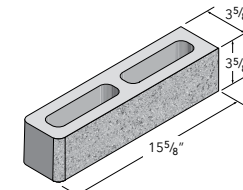

4x4x16 Double Bullnose

P | GF | SBL | GFS

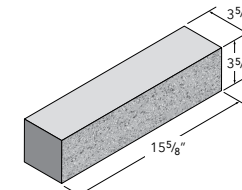

4x4x16 Solid

P | C | SF | GF | SBL | GFS

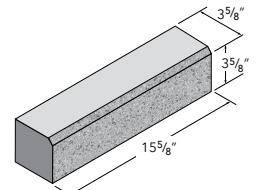

4x4x16 Solid Chamfer

P | GF | SBL | GFS

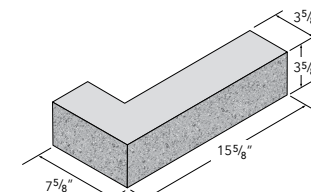

4x4x16x8 L Return

P | C | SF | GF | SBL | GFS

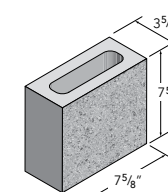

4x8x8 Standard

P | C | SF | GF | SBL | GFS

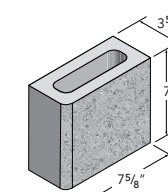

4x8x8 Single Bullnose

P | GF | SBL | GFS

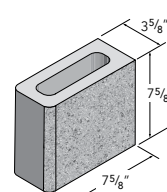

4x8x8 Double Bullnose

P | GF | SBL | GFS

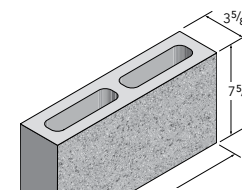

4x8x16 Standard

P | C | SF | GF | SBL | GFS

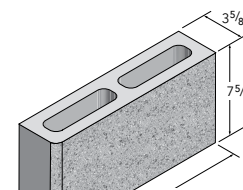

4x8x16 Single Bullnose

P | GF | SBL | GFS

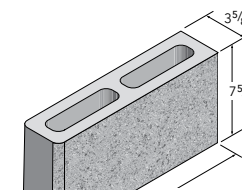

4x8x16 Double Bullnose

P | GF | SBL | GFS

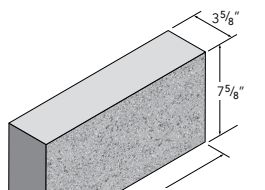

4x8x16 Solid

P | C | SF | GF | SBL | GFS

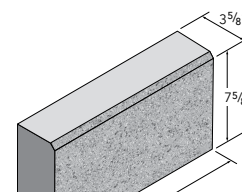

Solid Chamfer 4x8x16

P | GF | SBL | GFS

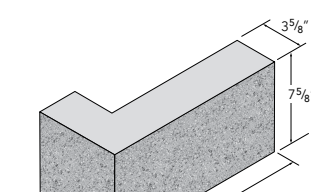

4x8x16x8 L Return

P | C | SF | GF | SBL | GFS

P | Precision C | Comb SF | Split Face GF | Ground Face SBL | Shot Blast GFS | Ground Face Shot Blast

TEXTURES

Basalite CMU is available in six textures. Precision, Comb, Split Face, Ground Face, Shot Blast and Ground Face Shot Blast. See page 12 for texture samples.

SHAPES | 6 INCH CMU

For texture availability please refer to the letter designation under each shape.

SHAPES | 8 INCH CMU

For texture availability please refer to the letter designation under each shape.

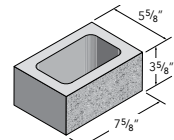

6x4x8
Standard

P | C | SF | GF | SBL | GFS

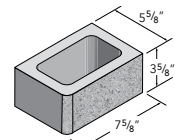

6x4x8
Single Bullnose

P | GF | SBL | GFS

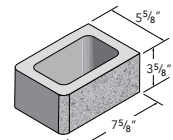

6x4x8
Double Bullnose

P | GF | SBL | GFS

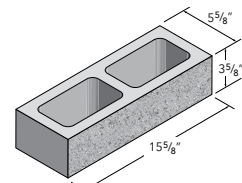

6x4x16
Standard

P | C | SF | GF | SBL | GFS

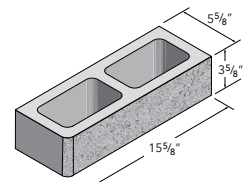

6x4x16
Single Bullnose

P | C | SF | GF | SBL | GFS

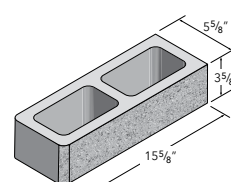

6x4x16
Double Bullnose

P | GF | SBL | GFS

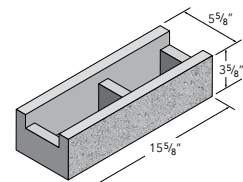

6x4x16
Bond Beam

P | C | SF | GF | SBL | GFS

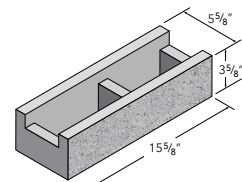

6x4x16
Solid Bottom Bond Beam

P | C | SF | GF | SBL | GFS

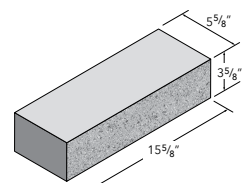

6x4x16
Solid

P | C | SF | GF | SBL | GFS

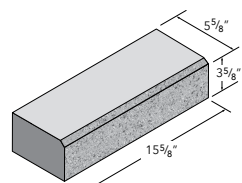

6x4x16
Solid Chamfer

P | GF | SBL | GFS

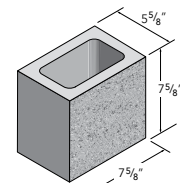

6x8x8
Standard

P | C | SF | GF | SBL | GFS

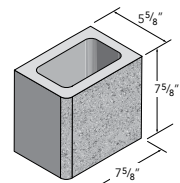

6x8x8
Single Bullnose

P | GF | SBL | GFS

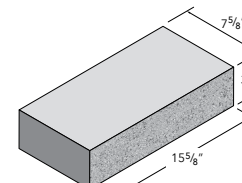

8x4x16
Solid

P | C | SF | GF | SBL | GFS

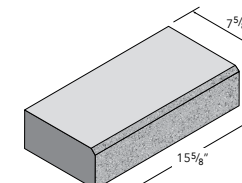

8x4x16
Solid Chamfer

P | GF | SBL | GFS

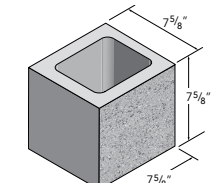

8x8x8
Standard

P | C | SF | GF | SBL | GFS

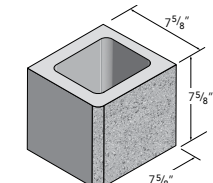

8x8x8
Single Bullnose

P | GF | SBL | GFS

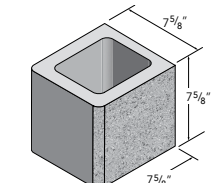

8x8x8
Double Bullnose

P | GF | SBL | GFS

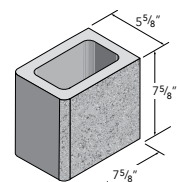

6x8x8
Double Bullnose

P | GF | SBL | GFS

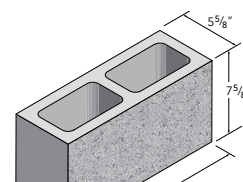

6x8x16
Standard

P | C | SF | GF | SBL | GFS

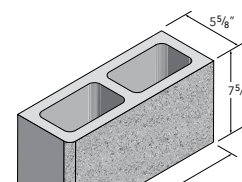

6x8x16
Single Bullnose

P | GF | SBL | GFS

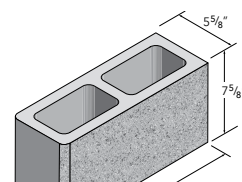

6x8x16
Double Bullnose

P | GF | SBL | GFS

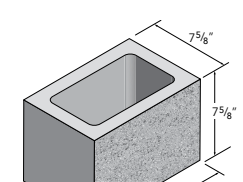

8x8x12
Standard

P | C | SF | GF | SBL | GFS

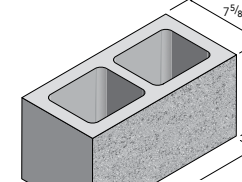

8x8x16
Standard

P | C | SF | GF | SBL | GFS

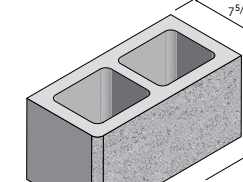

8x8x16
Single Bullnose

P | GF | SBL | GFS

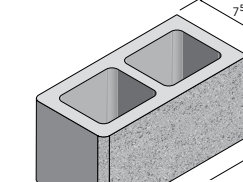

8x8x16
Double Bullnose

P | GF | SBL | GFS

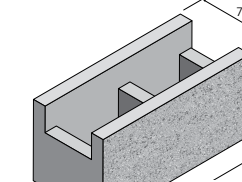

8x8x16
Bond Beam

P | C | SF | GF | SBL | GFS

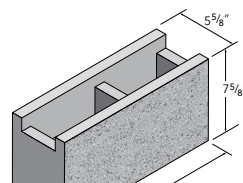

6x8x16
Bond Beam

P | C | SF | GF | SBL | GFS

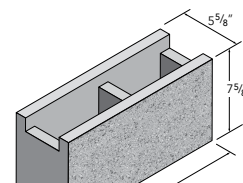

6x8x16
Solid Bottom Bond Beam

P | C | SF | GF | SBL | GFS

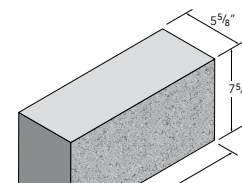

6x8x16
Solid

P | C | SF | GF | SBL | GFS

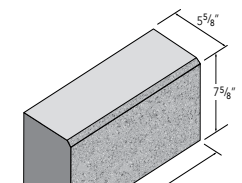

6x8x16
Solid Chamfer

P | GF | SBL | GFS

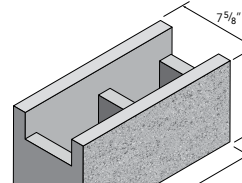

8x8x16
Solid Bottom Bond Beam

P | C | SF | GF | SBL | GFS

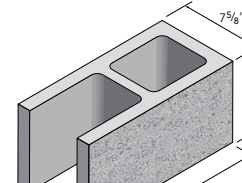

8x8x16
SCOE Block

P | C | SF | GF | SBL | GFS

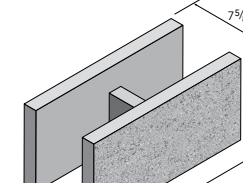

8x8x16
H Block

P | C | SF | GF | SBL | GFS

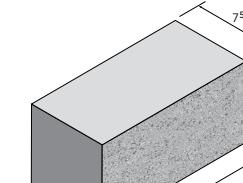

8x8x16
Solid

P | C | SF | GF | SBL | GFS

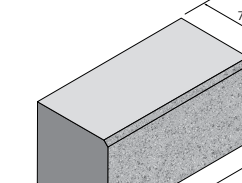

8x8x16
Solid Chamfer

P | GF | SBL | GFS

P | Precision C | Comb SF | Split Face GF | Ground Face SBL | Shot Blast GFS | Ground Face Shot Blast

P | Precision C | Comb SF | Split Face GF | Ground Face SBL | Shot Blast GFS | Ground Face Shot Blast

SHAPES | 10 INCH CMU

For texture availability please refer to the letter designation under each shape.

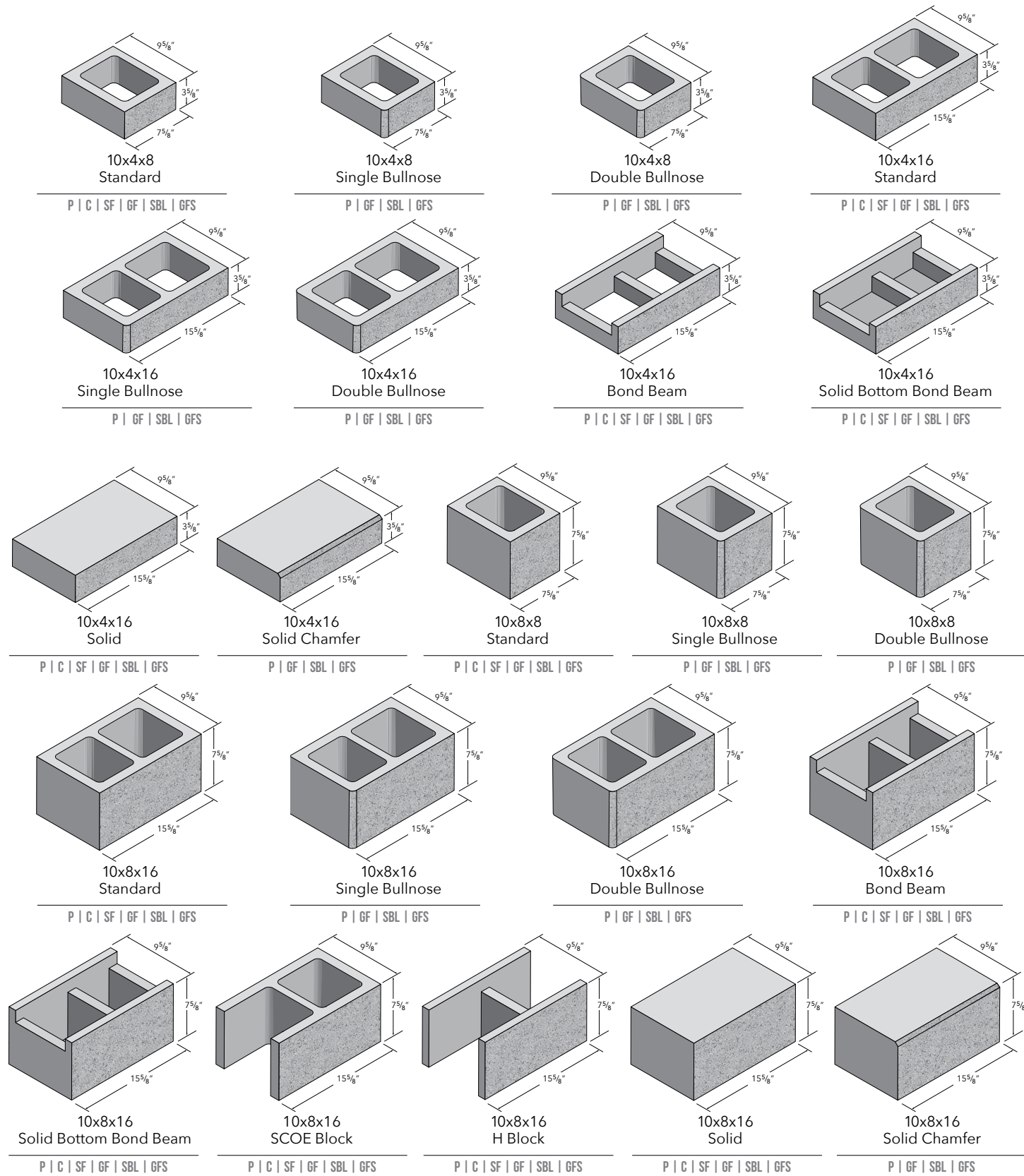

P | Precision C | Comb SF | Split Face GF | Ground Face SBL | Shot Blast GFS | Ground Face Shot Blast

SHAPES | 12 INCH CMU

For texture availability please refer to the letter designation under each shape.

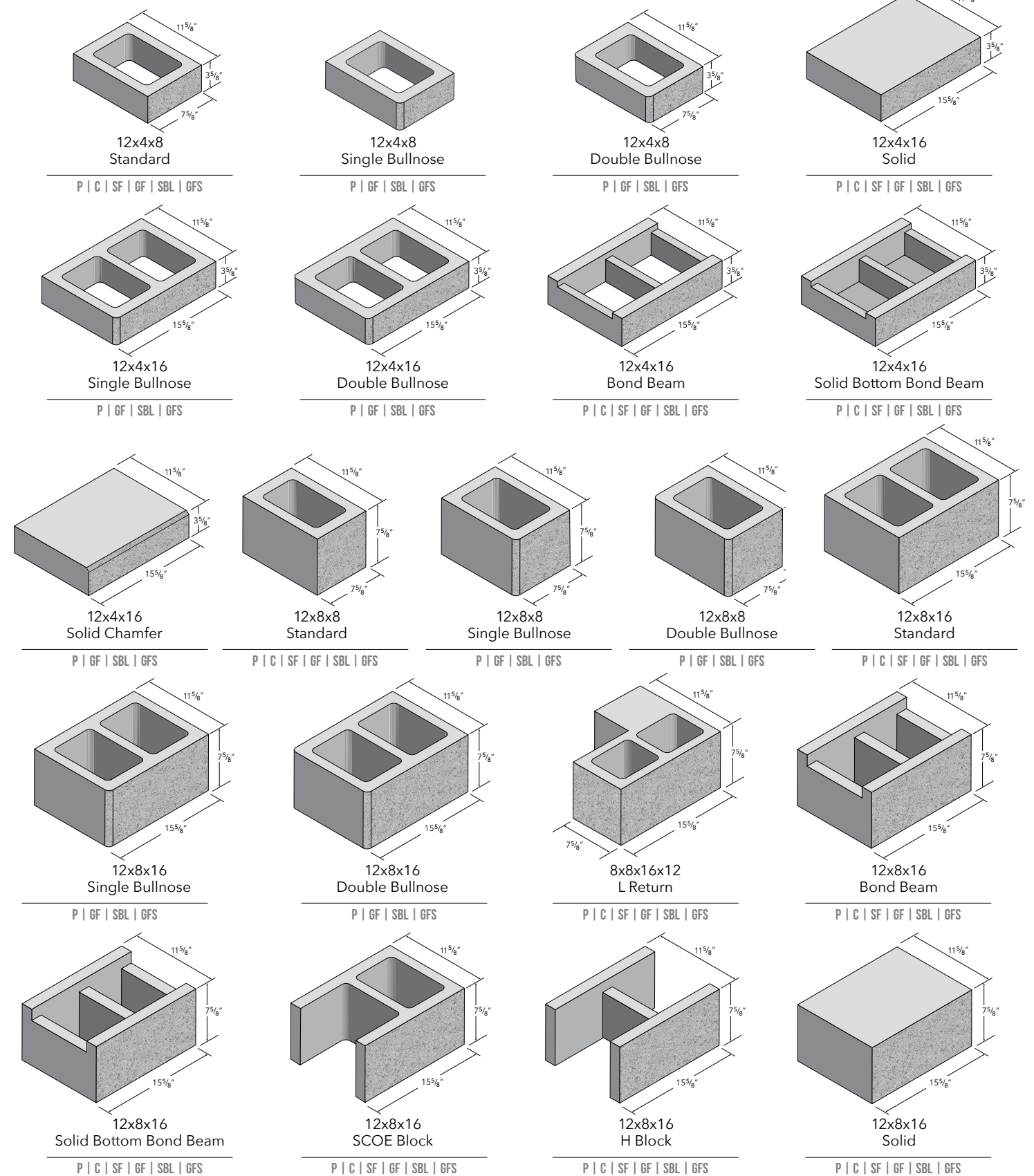

P | Precision C | Comb SF | Split Face GF | Ground Face SBL | Shot Blast GFS | Ground Face Shot Blast

SPECIALTY | SCREEN BLOCK

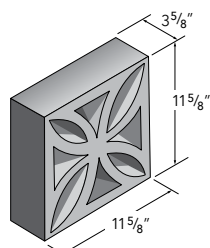

4x12x12
Viewlite 1

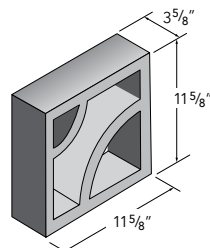

4x12x12
Viewlite 2

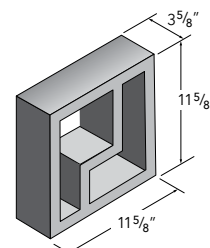

4x12x12
Viewlite 3



4x12x12
Viewlite 4

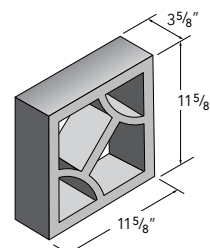

4x12x12
Viewlite 5

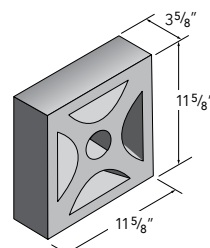

4x12x12
Viewlite 6

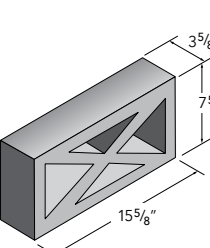

4x8x16

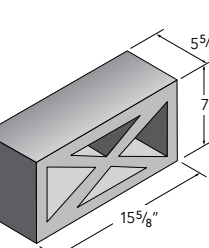

6x8x16

SPECIALTY | SPEC-BRICK®

Available in twelve standard colors. Visit www.basalite-cmu.com/colorado-specbrik for color swatches, email us at cmu@basalite.com or call 1-800-289-2562 for product samples.

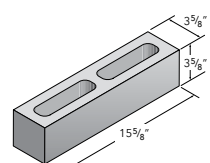

4x4x16
Spec-Brick

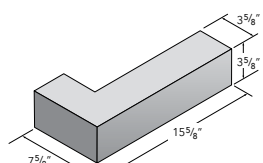

4x4x16
Spec-Brick L CNR

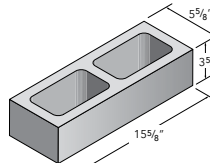

6x4x16
Spec-Brick

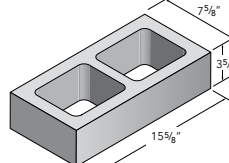

8x4x16
Spec-Brick

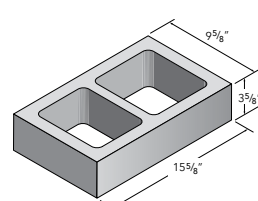

10x4x16
Spec-Brick

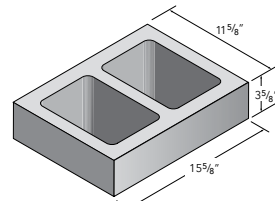

12x4x16
Spec-Brick

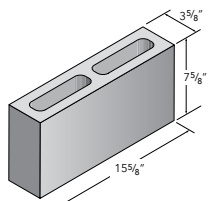

4x8x16
Spec-Brick

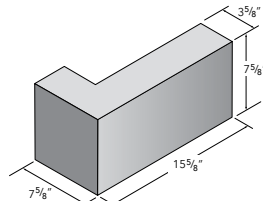

4x8x16
Spec-Brick L CNR

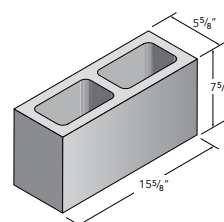

6x8x16
Spec-Brick

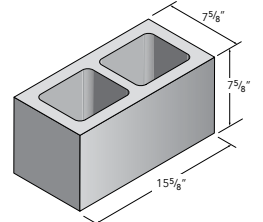

8x8x16
Spec-Brick

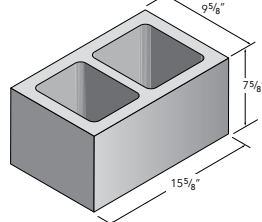

10x8x16
Spec-Brick

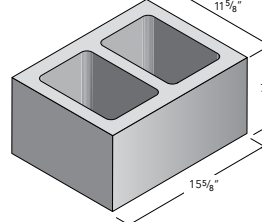

12x8x16
Spec-Brick

TEXTURES | OPTIONS



P | PRECISION

Smooth-faced and straight-edged.



C | COMB

Smooth-face with comb texture.



SF | SPLIT FACE

Rough, uneven texture with exposed aggregate.



GF | GROUND FACE

Ground smooth to expose the natural color of the aggregates.



SBL | SHOT BLAST

Factory applied media blast that highlights aggregates and adds subtle texture.



GFS | GROUND FACE SHOT BLAST

Two step process of grinding and factory media blast that adds color depth and subtle texture.

COLORS | GROUND FACE

Additional color options are available. Visit basalite-cmu.com/colorado-ground-face-cmu-color, email us at cmu@basalite.com or call 1-800-289-2562.

STANDARD COLORS



Printed colors shown in this brochure may vary from actual product colors. We recommend selecting colors from actual product samples.

COLORS | SPLIT FACE

Additional color options are available. Visit basalite-cmu.com/colorado-split-face-cmu-colors, email us at cmu@basalite.com or call 1-800-289-2562.

STANDARD COLORS



Printed colors shown in this brochure may vary from actual product colors. We recommend selecting colors from actual product samples.